

NEW-FLOW

**ISO 9001
REGISTERED**

Mass Flow Meters

T Series

Instruction Manual

操作手冊



NEW-FLOW TECHNOLOGY, INC.

TABLE OF CONTENTS

1.0 Introduction and Description	page 2
2.0 Specifications	page 3
3.0 Installation	page 4
3.1 Plumbing Connections	page 4
3.2 Electrical Connections.....	page 4
3.21 Power	page 4
3.22 Output.....	page 4
3.23 Set Point.....	page 4
3.24 D Conn Pin Cut	page 4
4.0 Operation.....	page 5
4.1 Zero Check.....	page 5
4.11 Display Zero	page 5
4.12 0-5 Output Zero	page 5
4.2 Flow Measurement.....	page 5
4.3 Flow Control.....	page 5
5.0 Using K Factors.....	page 6
Simple Operating Manual	page 7-9
中文簡式操作手冊.....	page 10-12
Index of Appendix	
Appendix a Gas K Factors.....	page 13-16

TEL: 886-7-8135500 FAX: 886-7-8225588
e-mail: info@new-flow.com
http://www.new-flow.com
Instruction No. 20140704-1

1.0 DESCRIPTION

New-Flow Technologies T Series mass flow meters and controllers utilize a capillary type thermal technology to directly measure mass flow. No temperature, pressure, or square root corrections are required.

The T Series is available with an LCD display and linear 0-5 or 4-20 ma output. Readout may be in mass units such as Gr/s, LB/H, Kg/H... or in volumetric units referenced to a standard pressure and temperature I.E. SCCM, SLPM, SCFH. New-Flow uses °C and 760 mmHg as standard reference conditions. (Others available on request).

The T Series is available in TPCON or 316 Stainless Steel. TPCON is compatible with most non-corrosive gases. The user is responsible to check wetted materials against gas compatibility.

New-Flow mass flow meters are calibrated to NIST standards for a specific gas and range selected by the customer, however K factors can be used to measure other gases.

T Series controllers use an integral electromagnetic proportional valve to control the mass flow rate. Command signal is supplied by the on board set point pot or a external 0-5 VDC supplied through the D connector.

New-Flow's cost saving design supplies a complete flow measurement and control system in one compact package making it ideal for OEM, laboratories, Medical, Process Control, Pharmaceutical, Leak Detection, R&D, Gas Blending and process control applications.



2.0 SPECIFICATIONS

Wetted Material	Flow Bodies	<u>Plastic</u>	<u>Stainless Steel</u>
	Elastomers	TPCON, 316 & 17-4 SS Standard – Viton Optional – Buna, Kal – Rez, or EPDM.	316 SS & 17-4SS
Out put Singal	Linear 0 – 5 VDC or 4 – 20MA		
Input Power	Standard: 24 VDC @ 350 MA Optional: 12, 15 VDC / 115, 220 VAC with AC adapter		
Accuracy	±1% FS (including Linearity)		
Connection	9 pin Sub D		
Control Signal	Integral or 0–5 VDC		
Control Valve	Electromagnetic Norm. Closed		
Max Pressure	Plastic Model – 250 PSIG Stainless Model – 500 PSIG		
Response Time	1-2 second		

3.0 INSTALLATION

3.1 Plumbing

(Caution: The T Series has a maximum temperature of 150F and maximum pressure of 250 psig for plastic, 500 psig for Stainless Steel models.)

The T Series has #4 self tapping mounting holes on the bottom for permanent installations. A variety of fitting options are available including 1/4" fnpt, 3/8"fnpt, 1/4" swg. And 3/8" swg.

When plumbing meters insure the flow arrow on the front label is in the direction of flow.

Before operation insure system is leak free. Use a thread sealant for fnpt models.

Capillary mass meters are susceptible to clogging. If your line or gas has particulate entrained use a 50 – 100 micron filter up stream of the meter.

3.2 Electrical

3.2.1 Power

New-Flow T Series meters require 24 VDC @ 250 ma for meters and 320 ma for controllers, via the 9 pin sub D connector. Power is typically supplied with a wall mounted AC adapter.

3.2.2 Output

New-Flow T Series has a standard 0 – 5 VDC or optional 4 – 20 ma linear output from the 9 pin sub D connector. The 4 – 20 ma signal is a self powered "4 wire type" referenced from ground, do not apply power to this line.

3.2.3 Setpoint

The T Series controllers require a linear 0 – 5 VDC setpoint. This signal can be supplied from the integral setpoint pot located on the left side of the controller, or from a remote source. The integral setpoint is jumpered through the mating sub D connector from pins 9 to 5. To use a remote setpoint signal, open the mating connector housing and remove the jumper on pins 9 to 5. Wire remote 0 – 5 to pins 5(Hi), 2 (Common).

3.2.4 D Conn. Pin Out

Pin Number

No.	Funtion	Color
1.	Power Supply Ground	White
2.	Set Point Input Lo	Purple
3.	4~20mA Output Hight	Blue
4.	0~5 VDC Output High	Orange
5.	Setpoint Input Hi	Red
6.	NC	
7.	24 VDC Power Input	Black
8.	Output Ground	Brown

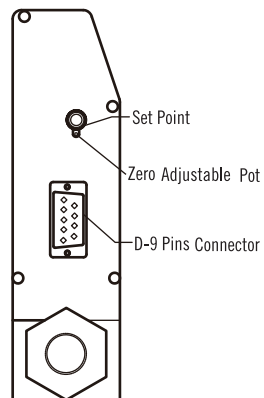
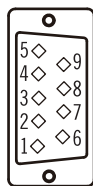

4.0 OPERATION

Apply power through the sub D connector and allow 5 – 10 minutes warm up time. Controllers should have a zero setpoint. For local setpoint models turn the setpoint adjustment knob fully clockwise.

4.1 Zero Check

Zero may shift in shipping or installation. Zero should be adjusted after installation to insure accuracy.

Insure there is no flow through the transducer and check the 0 – 5 output or display for a zero reading.

4.11 Display Zero

Adjust zero pot (R5) available through the side panel of the transducer until display reads 000.

4.12 0 – 5 Output Zero

Adjust zero pot (R5) available through the side panel of the transducer until the output on pins 4 & 8 climbs to +0.050 VDC or above, then slowly lower output until output stops falling (approx. 0.007 VDC).

4.2 Flow Measurement

The T Series transducers measure mass flow directly and read out in mass units per time. When calibrated for volumetric units measurements are referenced from a standard temperature and pressure. Outputs are linear over the calibrated flow range with an accuracy of $\pm 1\%$ of Full Scale, 100:1 Turn Down.

4.3 Flow Control

Flow controllers combine a mass flow transducer with an electromagnetic proportional valve. Valves are not recommended as shut off valves. Controllers use a 0 – 5 VDC linear setpoint signal supplied from the local setpoint pot or from a remote source. The local setpoint voltage must be connected through the external mating D connector from pins 9 to 5. This will enable the knob on the side of the mass flow controller. For remote setpoint remove this jumper and wire 0 – 5 VDC to pins 2 and 5. Valves have a standard minimum and maximum operating differential pressures of 10 – 50 PSIG. Others available on request.

5.0 USING K FACTORS

The T Series uses a thermal sensor technology which allows the use of conversion factors the calibrated gas to other gases. To change to a new gas multiply the flow rate reading by the ratio of the K factor for the new gas to the K factor of the calibrated gas.

$$\text{Reading} \quad \times \quad \frac{\text{K Factor Cal. Gas}}{\text{K Factor New Gas}}$$

Accuracy is $\pm 4\%$ using this method.



T SERIES MASS FLOW METERS

Wiring Method

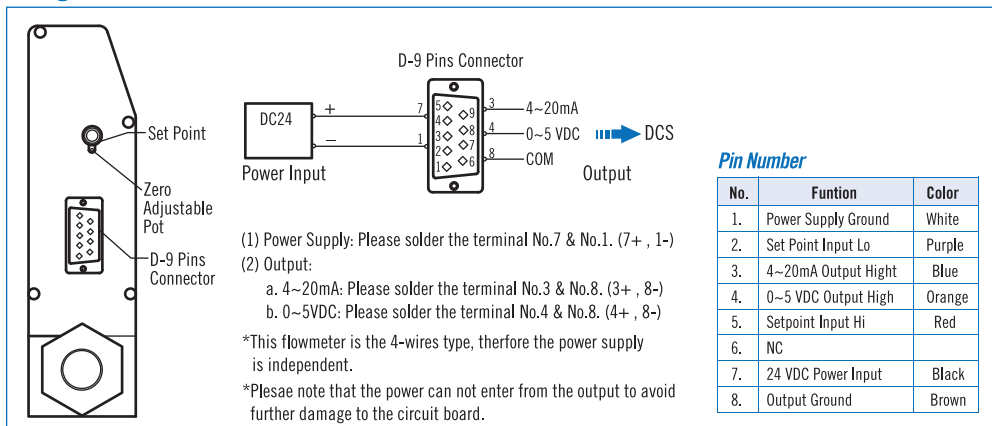

Zero Check

If display has not shown in the zero point when the power supply is on for 5~10 minutes, please proceed to adjust it return zero. Two kinds of operations for return zero, one is display returns zero and other is output is signal returns zero. Please note both of them are synchronous action. When the display is shown "0", then output must be "0".

1. Display Zero

Please use flat-head screwdriver to turning the zero adjustable pot by clockwise or counterclockwise until the display value is "000". Increase the display value for rotating clockwise, rotating counterclockwise to decrease the display value. (Please adjust it by fine-turning, not main-turning.)

2. Output Zero (Signal Output)

The operation of return zero is as above. The voltage returns zero that have to use the circuit tester. Solder the terminal No.4 & No.8 to adjust the display value of circuit tester ≈ 0.007 VDC, it means this operation is completed. When output is 4~20mA (4-wires type), please solder the terminal No.3 & No.8 to adjust the electric current return zero. The meantime display value is synchronous "000".

Flow Control While TLFC Mass Flow Meter was used, the operating differential pressure has to follow as Table below:

Operating Differential Pressure

F.S ≈ 5 SLM (0.5 kg/cm² ~3 kg/cm²)

Low differential pressure specification depend on types of gas and flow rates to be used,

5 SLM < F.S < 20 SLM (1 kg/cm² ~3 kg/cm²)

20 SLM < F.S < 50 SLM (2 kg/cm² ~3 kg/cm²)

a. Integral-Manual Set Point

1. Connect the terminal No.5 & No.9 jump at D type, then directly adjust the flow rate from set point above the main body. Decrease the flow rate for rotating clockwise, rotating counterclockwise to increase the flow rate.
2. Using a ON/OFF switch to get connected in a terminal No.5 & No.9 for remote ON/OFF control mode available. No.5 & No.9 short circuit.
3. Adjust flow rate of request by set point. For instance, the maximum display value is 5 SLM, then switch on the ON/OFF switch (switch is in the ON position),

9 pins D connector

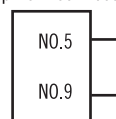

(for a-1)

T SERIES MASS FLOW METERS

4. Display value decrease to 0.0 from 5 SLM when the switch turned into OFF.
5. When switch turned into ON again, flow value will be over 5 SLM on display. After 7~10 seconds, flow value will stable on 5 SLM.

b. Remote-Signal Input

1. Connect the terminal No.5 with positive electrode and No.2 with negative electrode when you usage the remote input 0~5 VDC. Terminal No.5 & No.9 don't need to connect jump.
For instance, the flow rate of display is 0~5 L/M when the input is 0~5 VDC.
Control mode is as follows: the display has shown 3 L/M when the input voltage is 3V, it means the flow rate of display is the 3V voltage of input, and the accuracy is $\pm 1\%$ F.S .

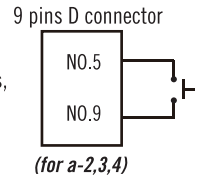

2. Using a ON/OFF switch connected with input to control the switch ON and OFF. When the input voltage is 0~5 VDC, the display flow value is 0~5 SLM.

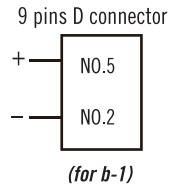

4. Display value decrease to 0.0 from 5 SLM when the switch turned OFF.
5. When switch turned ON again, flow value will be over 5 SLM on display. After 7~10 seconds, flow value will stable on 5 SLM.

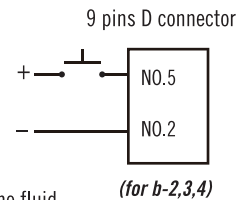

- *c. If you choose item a or b for TLFC, please follow the intructions for setting otherwise the fluid will not go through by normal direction. It is cause "inner control valve" does not open.

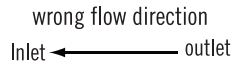
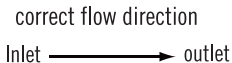

Span Adjustable

If the accuracy distortion, please send back t o our factory to calibrating it by the standard adjustment of instrument.

TLF-FT TOTALIZER SYSTEM

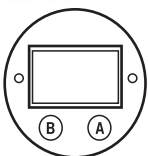

User Notice

1. Make the PIN.3 and PIN.8 short circuit before using the totalizer LCD display. Otherwise the LCD will not display.
2. If the PIN.3 and PIN.8 connect with 4~20mA output, then it won't be short circuit.

Flow Rate Unit Adjustalbe (S.UN): ℓ / Min

Time Unit Adjustment:

Press "A/B", LCD display: Up part: "S.Un"; Middle part "000000.00"; and Bottom part "ℓ/min",
Press "B+A" LCD display: Bottom part "ℓ / min"
Press "B" LCD display: Bottom part "ℓ / sec", then press "B" again, the unit will be changed step by step from "/day, /h, /min, /sec,...", adjust the unit by your required.
Then press "B+A", LCD display: Up part: "S.Un"; Middle part "000000.00"; and Bottom part "ℓ/h", and press "A/B" to back to the usage mode.
LCD display: Up part "0000xxxx.xx"; Middle part "000015.00" (actual sensor input value) ; and Bottom part "ℓ/h", (according to the final adjusted value).

NOTE:

When you change the unit of /day or /h, 20mA means the value of flow rate over 8 digits, and the LCD display "OUEr" (flashing)

TLF-FT TOTALIZER SYSTEM

Batch Totalizer Flow Rate Zero Adjustable

Press “B”, the up part of LCD display “0000xxxx.xx” by flashing; middle “bAtch” and bottom “ℓ”.

Press and hold “B” and press “A” at the same time to make the batch flow rate to back to “zero”.

Release “A” and “B” to back to the usage mode.

The bototm part of LCD display “00000000.00”; middle “000000.x0” (actual sensor input value); bottom “kg/min”.

Total Accumulation (NO RESET FUNCTION)

Press and hold “A”

The up part of LCD display “09876543.21”; middle “ 2”; and bottom “ℓ”.

Release “A” to back to the mode of batch flow rate, and back to the usage mode.

The up part of LCD display “0000xxxx.xx” (original batch flow); middle “000000.x0” (actual sensor input value); and bottom “ℓ/min”.

NOTE:

Total accumulation displayed, the middle part of LCD display “ 2”, which means the value of total accumulation is exceeded two time 10 digits.

T SERIES MASS FLOW METERS

接線方式

DC24 Power Input

Set Point 旋鈕

Zero Adjustable Pot 零點調整

D-9 Pins Connector

7 + 4~20mA

1 - 0~5 VDC

3 4

4 8 COM

Output DCS

(1) Power Supply: 請焊接接腳 No.7 & No.1. (7+, 1-)

(2) Output 分為:

a. 4~20mA: 請焊接 No.3 & No.8. (3+, 8-)

b. 0~5VDC: 請焊接 No.4 & No.8. (4+, 8-)

*此流量計是為4線式，所以供應電源是獨立的。不可另接電源由輸出端進入，以避免電路板損毀。

Pin Number		
項目	功能	顏色
1.	Power Supply Ground	白
2.	Set Point Input Lo	紫
3.	4~20mA Output High	藍
4.	0~5 VDC Output High	橘
5.	Setpoint Input Hi	紅
6.	NC	
7.	24 VDC Power Input	黑
8.	Output Ground	棕

零點調整

輸入電源及暖機5~10分鐘後，如顯示並沒有在零點，請進行歸零動作。
動作分為2種，顯示器歸零及Output歸零，兩者均為同步，顯示器為0時，則Output也須為0。

1. Display Zero

請用一字螺起子“順時針”或“逆時針”旋轉，直到讀值為“000”。
順時針調整時讀值變大，逆時針則反之。(請微調整，不可大幅度調整)

2. Output Zero (Signal Output)

歸零動作如上。電壓歸零必須利用三用電錶，接上Output 4和8接腳，調整電錶上的讀值 ≈ 0.007 VDC 即完成歸零動作。此時讀值必同步為“000”。當輸出4~20mA(4線式)時，請接上接腳3和8，進行電流歸零動作。

流量控制 TLFC流量控制器使用時有操作差壓(ΔP)的限制如下：

$$F.S \leq 5 \text{ SLM } (0.5 \text{ kg/cm}^2 \sim 3 \text{ kg/cm}^2)$$

低差壓規格取決於所使用的氣體和流速

$$5 \text{ SLM} < F.S < 20 \text{ SLM } (1 \text{ kg/cm}^2 \sim 3 \text{ kg/cm}^2)$$

$$20 \text{ SLM} < F.S < 50 \text{ SLM } (2 \text{ kg/cm}^2 \sim 3 \text{ kg/cm}^2)$$

a. 手動調整

1. 使D型接頭中的接腳5&9短路，即可直接於本體入口處上方旋轉處調整流量大小。順時針旋轉流量愈小，逆時針則愈大。
2. 可利用一只ON/OFF開關串接在No.5及No.9連線中間做遠距離控制，No.5 & 9短路。
3. 利用旋鈕調整需要的固定流量，最大Display顯示值例如為5 SLM，接著啟動開關ON/OFF。(此時開關在ON的位置)
4. 當開關為OFF時，Display的顯示值從5 SLM降為0.0。
5. 當開關為ON時，Display的瞬間最大流量值會大於5 SLM，經過7~10秒後，流量值會穩定於5 SLM。

9 pins D connector

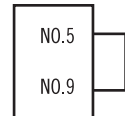

(for a-1)

9 pins D connector

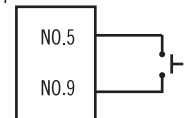

(for a-2,3,4)

T SERIES MASS FLOW METERS

b. 外部信號輸入

1. 使用外部輸入0~5 VDC，將D型接頭中No.5接上電源正極，No.2接上負極即可。不需使接腳5&9短路。
例如：輸入電壓為0~5 VDC流量顯示即為0~5 L/M。控制模式為，當輸入3V電壓時，流量顯示即3為3V的流量，誤差為±1% F.S。
2. 可利用一只 ON/OFF 開關串聯接在輸入線上做 ON/OFF 的動作。輸入電壓為 0~5VDC 時，Display 顯示值為 0~5 SLM。
3. 當開關為 OFF 時，Display 的顯示值從 5 SLM 降為 0.0。
4. 當開關為 ON 時，Display 的瞬間最大流量值會大於 5 SLM，經過 7~10 秒後，流量值會穩定於 5 SLM。

*c. 輸入電源後如果a.b.項都沒有執行接線，則流量無法由正常流向流過去。因為內部的控制閥們沒有打開。

9 pins D connector

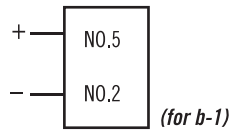

9 pins D connector

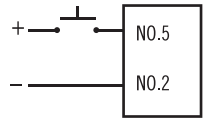

正確流向

入口 → 出口

錯誤流向

入口 ← 出口

精度失真

如精度失真，請送回原廠依標準儀器校正。

TLF-FT TOTALIZER SYSTEM



使用需知

1. 使用 Totalizer LCD Display 前，需使 PIN.3 及 PIN.8 短路。否則 LCD Display 將無法顯示。
2. 若 PIN.3 及 PIN.8 有接 4~20mA 輸出訊號時，則不用短路。

流速單位調整 (S.UN): ℓ/Min

只調整時間單位：

按“A/B” LCD上排顯示“S.Un”中排顯示“000000.00” and 下排顯示“ℓ/min”，

按“B+A” LCD下排顯示“ℓ/min”

按“B” LCD下排顯示“ℓ/sec”，再按“B”其單位如下列順序改變“/day, /h, /min, /sec, ...”

根據需要將所需單位值完成調整。

然後按“B+A”，LCD上排顯示“S.Un”中排顯示“000000.00” and 下排“ℓ/h”，再按“A/B”，回到使用模式。

LCD上排顯示“0000xxxx.xx”，中排顯示“000015.00”（實際Sensor輸入值）and 下排“ℓ/h”（依實際最後調整值）。

NOTE.

轉變/day or /h時，20mA代表量超過8位數，LCD 顯示“OUE”（閃爍）。

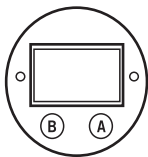

單次累計流量歸零

按“B”上排顯示閃爍“0000xxxx.xx”，中排顯示“bAtch” and 下排“ℓ”。

按住“B”同時按“A”單次流量“歸零”，

放開“A” and “B” 回復工作模式。

LCD上排顯示“00000000.00”，中排顯示“000000.x0” (實際Sensor輸入值) and 下排 “ ℓ/min ”。

顯示總流量 (Total Accumulation) (不可重新設定)

按住“A”

LCD上排顯示“09876543.21”，中排顯示“ 2” and 下排“ℓ”。

放開“A”回復單次流量顯示 and 回復工作模式。

LCD上排顯示“0000xxxx.xx”(原單次流量), 中排顯示“000000.x0” (實際Sensor輸入值) and 下排“ℓ/min”。

NOTE.

總流量顯示時, 中排顯示“ 2”, 表示總流量已超越過2次10位數。

Table 1: Conversion Factor Tables-relative to nitrogen N2 and test gas

GAS	SYMBOL	TEST GAS	CONVERSION TO TEST GAS	CONVERSION REACTOR REL. TO N2	SPECIFIC HEAT, Cp cal/g C	DENSITY g/l @ 0°C
Acetylene	C2H2	C2H4	.97	.58	.4036	1.162
Air	—	N2	1.00	1.00	.240	1.293
Allene (Propadiene)	C3H4	CHCLF2	.95	.43	.352	1.787
Ammonia	NH3	N2O	1.03	.74	.492	.760
Argon	Ar	Ar	1.00	1.42	.1244	1.782
Arsine	AsH3	N2O	.95	.67	.1167	3.478
Boron Trichloride	BCL3	CHCLF2	.89	.41	.1279	5.227
Boron Trifluoride	BF3	CHCLF2	1.11	.51	.1778	3.025
Bromine	Br2	N2O	1.14	.81	.0539	7.130
Boron Tribromide	BBr3	CCL2F2	1.07	.38	.0647	11.18
Bromine Pentafluoride	BrF5	CCL2F2	.72	.26	.1369	7.803
Bromine Trifluoride	BrF3	CCL2F2	1.09	.38	.1161	6.108
Bromotrifluoromethane (Freon-13 B1)	CBrF3	CCL2F2	1.04	.37	.1113	6.644
1,3-Butadiene	C4H6	CCL2F2	.91	.32	.3514	2.413
Butane	C4H10	CCL2F2	.74	.26	.4007	2.593
1-Butane	C4H8	CCL2F2	.85	.30	.3648	2.503
2-Butane CIS/TRANS.	C4H8	CCL2F2	.92/.82	.33/.29	.336/.374	2.503
Carbon Dioxide	CO2	N2O	1.04	.74	.2016	1.964
Carbon Disulfide	CS2	C2H4	1.00	.60	.1428	3.397
Carbon Monoxide	CO	N2	1.00	1.00	.2488	1.250
Carbon Tetrachloride	CCL4	CCL2F2	.88	.31	.128	6.860
Carbon Tetrafluoride (Freon-14)	CF4	CHCLF2	.92	.42	.1654	3.926
Carbonyl Fluoride	COF2	C2H4	.91	.54	.1710	2.945
Carbonyl Sulfide	COS	N2O	.93	.66	.1651	2.680
Chlorine	CL2	N2	.86	.86	.1144	3.163
Chlorine Trifluoride	CLF3	CHCLF2	.87	.40	.1650	4.125
Chlorodifluoromethane (Freon-22)	CHCLF2	CHCLF2	1.00	.46	.1544	3.858
Chloroform	CHCL3	CCL2F2	1.11	.39	.1309	5.326
Chloropentafluoroethane (Freon-115)	C2CLF5	CCL2F2	.68	.24	.164	6.892
Chlorotrifluoromethane (Freon-13)	CCLF3	CCL2F2	1.08	.38	.153	4.660
Cyanogen	C2N2	C2H4	.98	.45	.2613	2.322
Cyanogen Chloride	CLCN	C2H4	1.02	.61	.1739	2.742
Cyclopropane	C3H5	CHCLF2	1.00	.46	.3177	1.877
Deuterium	D2	N2	1.00	1.00	1.722	1.799
Diborane	B2H6	CHCLF2	.95	.44	.508	1.235
Dibromodifluoromethane	CBr2F2	CCL2F2	.55	.19	.15	9.362
Dibromomethane	CH2Br2	CHCLF2	1.02	.47	.075	7.76

APPENDIX A

Table 1 (continued): Conversion Factor Tables relative to nitrogen N2 and test gas

GAS	SYMBOL	TEST GAS	CONVERSION TO TEST GAS	CONVERSION REACTOR REL. TO N2	SPECIFIC HEAT, Cp cal/g C	DENSITY g/l @ 0°C
Dichlorodifluoromethane (Freon-12)	CCL2F2	CCL2F2	1.00	.35	.1432	5.395
Dichlorofluoromethane (Freon-21)	CHCL2F	CHCLF2	.93	.42	.140	4.952
Dichloromethylsilane	(CH3)2SiCL2	CCL2F2	.71	.25	.1882	5.758
Dichlorosilane	SiH2Cl2	CHCLF2	.88	.40	.150	4.506
1,2-Dichlorotetrafluoroethane (Freon-114)	C2CL2F4	CCL2F2	.63	.22	.160	7.626
1,1-Difluoroethylene (Freon-1132A)	C2H2F2	CHCLF2	.93	.43	.224	2.857
Dimethylamine	(CH3)2NH	CCL2F2	1.05	.37	.366	2.011
Dimethyl Ether	(CH3)2O	CCL2F2	1.10	.39	.3414	2.055
2,2-Dimethylpropane	C3H12	CCL2F2	.61	.22	.3914	3.219
Disilane	Si2H6	CCL2F2	.89	.32	.310	2.776
Ethane	C2H6	CHCLF2	1.08	.50	.4097	1.342
Ethanol	C2H6O	CCL2F2	1.11	.39	.3395	2.055
Ethyl Acetylene	C4H6	CCL2F2	.91	.32	.3513	2.413
Ethyl Chloride	C2H5CL	CCL2F2	1.10	.39	.244	2.879
Ethylene	C2H4	C2H4	1.00	.60	.365	1.251
Ethylene Oxide	C2H4O	CHCLF2	1.13	.52	.268	1.965
Fluorine	F2	N2	.98	.98	.1873	1.695
Fluoroform (Freon-23)	CHF3	CHCLF2	1.08	.50	.176	3.127
Freon-11	CCL3F	CCL2F2	.93	.33	.1357	6.129
Freon-12	CCL2F2	CCL2F2	1.00	.35	.1432	5.395
Freon-13	CCLF3	CCL2F2	1.08	.38	.153	4.660
Freon-13 B1	CBrF3	CCL2F2	1.04	.37	.1113	6.644
Freon-14	CF4	CHCLF2	.92	.42	.1654	3.926
Freon-21	CHCL2F	CHCLF2	.93	.43	.140	4.952
Freon-22	CHCLF2	CHCLF2	1.00	.46	.1544	3.858
Freon-113	CCL2FCCLF2	CCL2F2	.57	.20	.161	8.360
Freon-114	C2CL2F4	CCL2F2	.63	.22	.160	7.626
Freon-115	C2CLF5	CCL2F2	.68	.24	.164	6.892
Freon-C318	C4F6	CCL2F2	.50	.18	.185	8.397
Germane	GeH4	C2H4	.950	.57	.1404	3.418
Germanium Tetrachloride	GeCL4	CCL2F2	.75	.27	.1071	9.565
Helium	He	He	1.00	1.43	1.241	.1786
Hexafluoroethane (Freon-116)	C2F6	CCL2F2	.68	.24	.1834	6.157
Hexane	C6H14	CHCLF2	.51	.18	.3968	3.845
Hydrogen	H2	H2	1.00	1.01	3.419	.0899
Hydrogen Bromide	HBr	N2	1.00	1.00	.0861	3.610

Table 1: Conversion Factor Tables-relative to nitrogen N2 and test gas

GAS	SYMBOL	TEST GAS	CONVERSION TO TEST GAS	CONVERSION REACTOR REL. TO N2	SPECIFIC HEAT, Cp cal/g C	DENSITY g/l @ 0°C
Hydrogen Chloride	HCL	N2	1.00	1.00	.1912	1.627
Hydrogen Cyanide	HCN	N2O	1.07	.76	.3171	1.206
Hydrogen Fluoride	HF	H2	1.00	1.00	.3479	.893
Hydrogen Iodide	HI	N2	1.00	1.00	.0545	5.707
Hydrogen Selenide	H2Se	N2O	1.11	.79	.1025	3.613
Hydrogen Sulfide	H2S	N2O	1.13	.80	.2397	1.520
Iodine Pentafluoride	If5	CCL2F2	.70	.25	.1108	9.90
Isobutane	CH(CH3)3	CCL2F2	.56	.20	.3872	3.593
Isobutylene	C4H6	CCL2F2	.83	.30	.3701	2.503
Krypton	Kr	Ar	1.00	1.41	.0539	3.739
Methane	CH4	N2O	1.01	.72	.5328	.715
Methanol	CH3OH	C2H4	.98	.58	.3274	1.429
Methyl Acetylene	C3H4	CHCLF2	.94	.43	.3547	1.787
Methyl Bromide	CH2Br	C2H4	.97	.58	.1106	4.253
Methyl Chloride	CH3CL	C2H4	1.05	.63	.1926	2.253
Methyl Fluoride	CH3F	C2H4	.93	.68	.3221	1.518
Methyl Mercaptan	CH3SH	CHCLF2	1.13	.52	.2459	2.146
Methyl Trichlorosilane	(CH3)SiCL3	CCL2F2	.71	.25	.164	6.669
Molybdenum Hexafluoride	MoF6	CCL2F2	.60	.21	.1373	9.366
Monoethylamine	C2H5NH2	CCL2F2	.99	.35	.387	2.011
Monomethylamine	CH3NH2	CCL2F2	.99	.45	.4343	1.386
Neon	NE	Ar	1.00	1.42	.246	.900
Nitric Oxide	NO	N2	1.00	1.00	.2328	1.339
Nitrogen	N2	N2	1.00	1.00	.2485	1.250
Nitrogen Dioxide	NO2	N2O	1.03	.74	.1933	2.052
Nitrogen Trifluoride	NF3	CHCLF2	1.05	.48	.1797	3.168
Nitrosyl Chloride	NOCL	C2H4	1.02	.61	.1632	2.920
Nitrous Oxide	N2O	N2O	1.00	.71	.2088	1.964
Octafluorocyclobutane (Freon-C318)	C4F8	CCL2F2	.47	.17	.185	8.397
Oxygen Difluoride	OF2	C2H4	1.06	.63	.1917	2.409
Oxygen	O2	N2	.99	.99	.2193	1.427
Pentaborane	B5H9	CCL2F2	.72	.26	.38	2.816
Pentane	C5H12	CCL2F2	.60	.21	.398	3.219
Perchloryl Fluoride	ClO3F	CCL2F2	1.16	.39	.1514	4.571
Perfluoropropane	C3F8	CCL2F2	.47	.17	.194	8.388
Phosgene	COCL2	CHCLF2	.97	.44	.1394	4.418
Phosphine	PH3	N2O	1.07	.76	.2374	1.517
Phosphorous Oxichloride	POCL3	CCL2F2	.85	.30	.1324	6.843
Phosphorous Pentafluoride	PF5	CCL2F2	.85	.30	.1610	5.620

APPENDIX A

Table 1 (continued): Conversion Factor Tables-relative to nitrogen N2 and test gas

GAS	SYMBOL	TEST GAS	CONVERSION TO TEST GAS	CONVERSION REACTOR REL. TO N2	SPECIFIC HEAT, Cp cal/g C	DENSITY g/l @ 0°C
Phosphorous Trichloride	PCL3	CCL2F2	1.01	.36	.1250	6.127
Propane	C3H8	CCL2F2	1.01	.36	.3885	1.967
Propylene	C3H6	CHCLF2	.90	.41	.3541	1.877
Silane	SiH4	C2H4	1.00	.60	.3189	1.433
Silicon Tetrachloride	SiCL4	CCL2F2	.80	.28	.1270	7.580
Silicon Tetrafluoride	SiF4	CCL2F2	.98	.35	.1691	4.643
Sulfur Dioxide	SO2	N2O	.96	.69	.1488	2.858
Sulfur Tetrafluoride	SF4	CCL2F2	1.00	.36	.1593	4.821
Sulfur Hexafluoride	SF6	CCL2F2	.74	.26	.1592	6.516
Sulfuryl Fluoride	SO2F2	CCL2F2	1.10	.39	.1543	4.562
Tetrafluorohydrazine	N2F4	CCL2F2	.91	.32	.182	4.64
Trichlorofluormethane	CCL3F	CCL2F2	.93	.33	.1357	6.129
Trichlorosilane	SiHCl3	CCL2F2	.93	.33	.1380	6.043
Trichloro-Trifluoroethane (Freon-113)	CCL2FCCLF2	CCL2F2	.57	.20	.161	8.360
Triisobutyl Aluminum	(C4H9)3AL	CCL2F2	.172	.061	.508	8.848
Titanium Tetrachloride	TiCL4	CCL2F2	.76	.27	.120	8.465
Trichloro Ethylene	C2HCL3	CCL2F2	.91	.32	.1495	5.862
Trichlorethane (TCA)	C2HCL3	CCL2F2	.78	.28	.1654	5.95
Trimethylamine	(CH3)3N	CCL2F2	.79	.28	.3710	2.639
Tungsten Hexasfluoride	WF6	CCL2F2	.54	.19	.1079	13.29
Uranium Hexafluoride	UF6	CCL2F2	.55	.20	.0888	15.70
Water Vapor	H2O	—	—	—	.455	.804
Vinyl Bromide	CH2CHBr	CHCLF2	1.01	.46	.1241	4.772
Vinyl Chloride	CH2CHCL	CHCLF2	1.04	.48	.2054	2.788
Xenon	Xe	Ar	1.00	1.42	.0378	5.858

NOTE: Conversion of controller to or from hydrogen or helium may seriously alter dynamic response or stability. Standard Pressure is defined as 760mm Hg (14.7 psia). Standard Temperature is defined as 0°C.



Golden Mountain Enterprise Co., Ltd.

No.9 Lane 133, Xing-Hua St., Chien Chen Dist. Kaohsiung 806, Taiwan

TEL: 886-7-8135500 FAX: 886-7-8225588

Email: info@new-flow.com

<http://www.new-flow.com>