



ISO 9001
REGISTERED

NEW-FLOW

MANUFACTURE OF PRESSURE SWITCH
PS SERIES & PSA SERIES
AND CONTROL INSTRUMENTS

壓力開關操作說明書

Instruction Manual



Approvals:



TD0400TJ
工電(2012)第00320號
(ITRI)2017第07-00075號

Patent No.

M295332
M334932
China: 920135

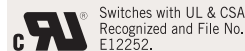

JAPAN EX-Certificate
CML 17JPN1016X
CML 17JPN3024

NEW-FLOW TECHNOLOGIES, INC.

No.9 Lane 133, Xing-Hua St., Chien Chen Dist., Kaohsiung 806, Taiwan

TEL: 886-7-8135500 FAX: 886-7-8225588 / 8159758

Email: info@new-flow.com www.new-flow.com

TABLE OF CONTENTS

1.0	Description & Installation.....	page 1
2.0	Range Setting & Wire Drawing.....	page 2
2.1	Wire Drawing.....	page 3
3.0	Cable Gland Installation.....	page 4

TEL: 886-7-8135500 FAX: 886-7-8225588
e-mail: info@new-flow.com
<http://www.new-flow.com>
Instruction No.: 20170817-1-pspsa



1.0 DESCRIPTION & INSTALLATION

Description & Storage Notice

規格與存放注意事項

Technical Data:

Electrical Rate Values: 15amps, 125/150V

Ambient Temperature: -20~40°C

Protection Class: Weather proof: NEMA 4, 4X, IP66

Explosion proof: (Certificate on Housing only) Class I, Groups B, C & D;
Class II, Groups E, F & G; NEMA 4, 7, 9

(EC-Type Examination) ITRI/Taiwan- Ex d IIB + H₂ T6 Gb

Housing Material: Aluminum alloy (ADC 12)

技術規格:

供電電力: 15amps, 125/150V

週圍溫度: -20~40°C

防護規格: 防水等級: NEMA 4, 4X, IP66

防爆等級: (防爆盒) Class I, Groups B, C & D; Class II, Groups E, F & G;
NEMA 4, 7, 9

(工研院整組型式認證) ITRI/Taiwan- Ex d IIB + H₂ T6 Gb

接線盒材質: 鋁合金 (ADC 12)

Product Features:

1. All of the electric parts which including the electronic components are placed inside of the housing case to protect.
2. The protection class of housing case, please refer to the Technical Data as above-mentioned.
3. The class of IP66 is for the weather proof type; and the class of IP68 is for the explosion proof type.
4. All the parts are screwed with the housing case tightly, and fixed by the socket set screw.
5. (Optional) The inlet of conduit assemblies with the cable gland. (Explosion proof cable gland sealed).

產品特性:

1. 所有帶電部分，電器電子元件等均置於器殼內保護。
2. 器殼保護等級，請參考上述防水等級及防爆等級。
3. 容器若為防水構造，保護(防水防塵)等級為IP66；若為防爆構造，保護(防水防塵)等級為IP68。
4. 構成容器之零組件採以螺絲(紋)旋緊之構造，並以止付螺絲固定之。
5. (選配)外部導線引入部位採電纜襯墊(耐壓防爆電纜固定頭封函)

Storage Place and Method:

1. If the pressure switch has not been used yet, please storage well to protect it under the normal function.
2. Please keep dry and well-ventilated to the storage place.
3. Please assemble the certificated cable gland for the installation. About the cable, specification and notice items, please refer to the page 3.

存放的場所及方式:

1. 壓力開關若不立即使用時，請做好存放措施，以保護壓力開關之正常機能。
2. 存放位置需通風良好與保持乾燥。
3. 安裝施工應選用合格之電纜接頭。電纜之配線，規格及注意事項請參考第三頁。

Principle 操作原理

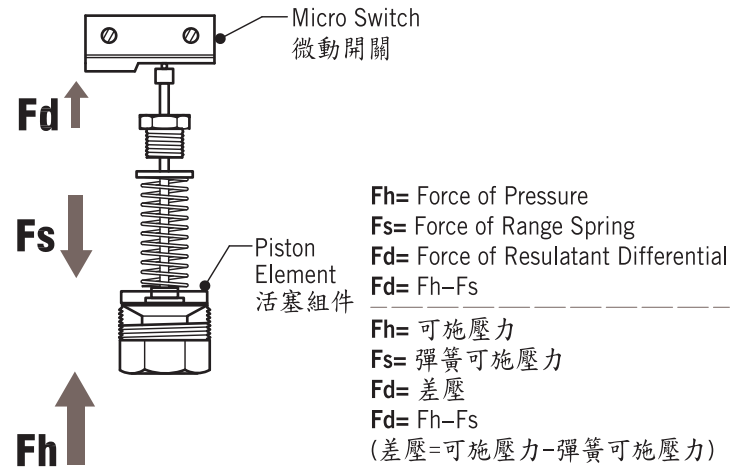

Process Installed Instruction 安裝方式

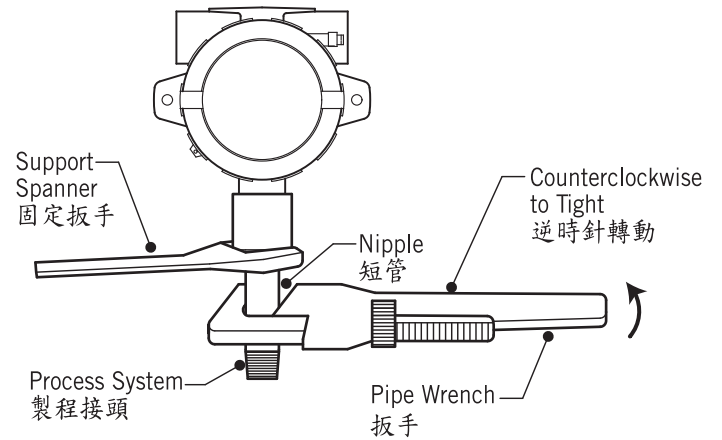

NOTICE:

Recommend "Vertical" installation.
建議「垂直」安裝。

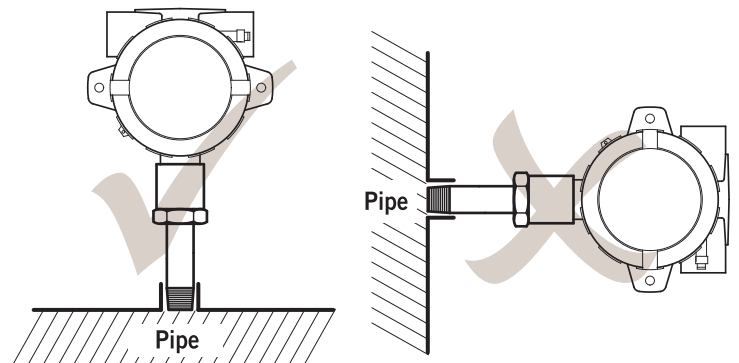

Correct: "Vertical" installation
正確: 「垂直」安裝。

Error: "Horizontal" installation
錯誤: 「水平」安裝。

2.0 RANGE SETTING

Construction Drawing 內部結構圖

Weather Proof Type
防水盒型式

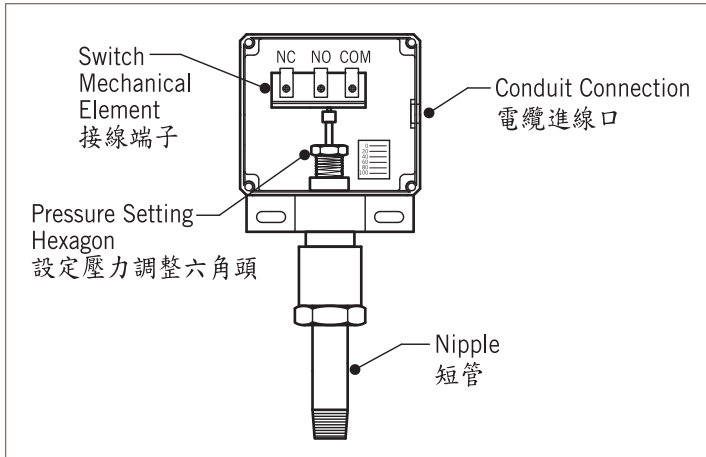

Explosion Proof Type
防爆盒型式

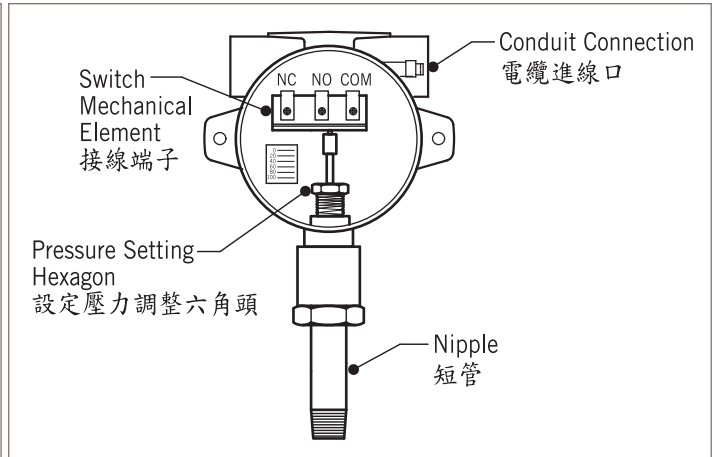

PS-Series Range Setting Method

PS系列可調範圍設定方法

Weather Proof Type
防水盒型式

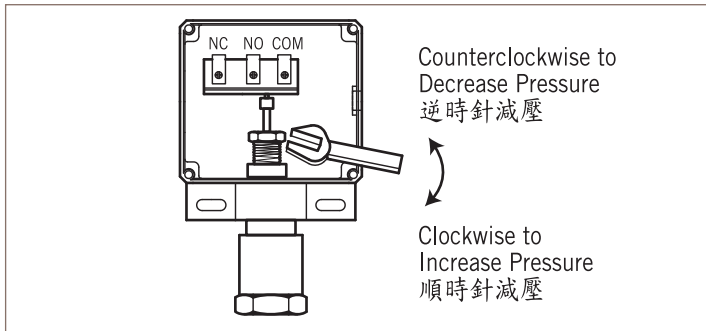

Explosion Proof Type
防爆盒型式

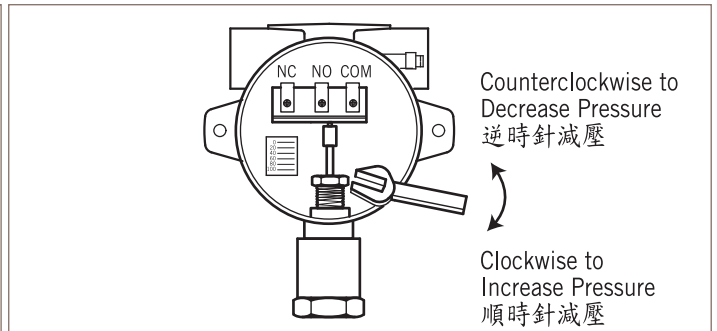

PSA-Series Range Setting Method

PSA系列可調範圍設定方法

Pressure setting hexagon is adjusted based on **E** point when ex-factory. To regulate the dead band, please rotate the gear dial on micro switch then choose the setting for A to F point.

出貨前，原廠會先將差壓調整旋鈕調整至**E**點。客戶欲調整dead band誤差時，可旋轉微動開關中錶盤上的齒輪，由A設定至F即可。

Weather Proof Type
防水盒型式

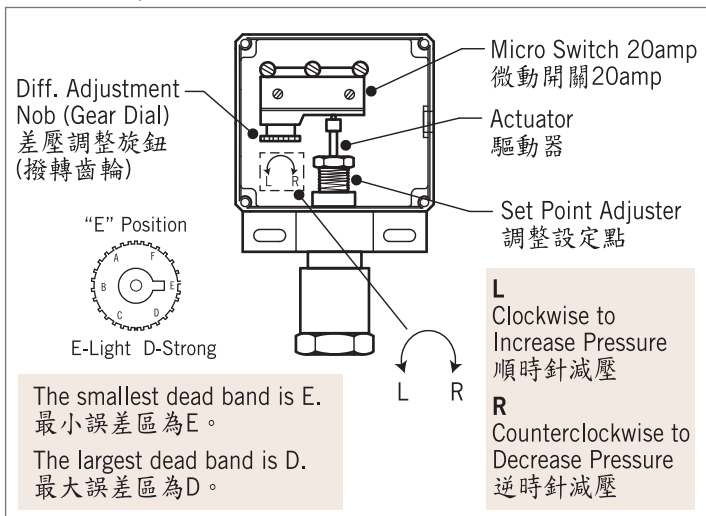

Explosion Proof Type
防爆盒型式

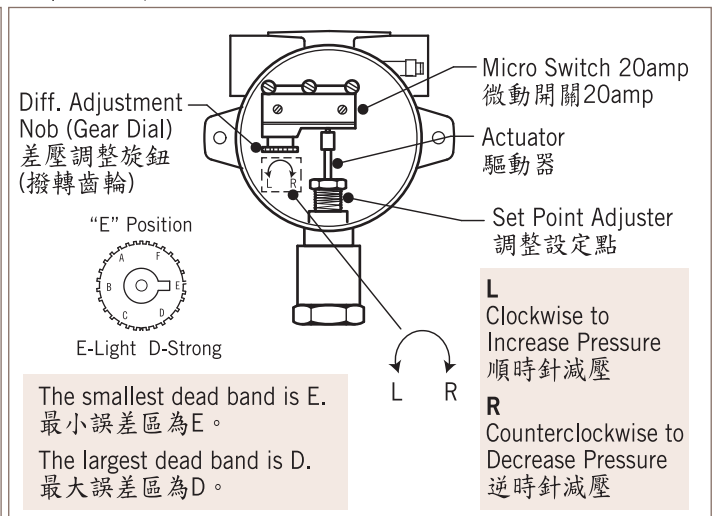

2.1 WIRE DRAWING

Wire Drawing/Micro Switch Rating

接線圖/微動開關功率

SPDT Wire Drawing SPDT 接線圖

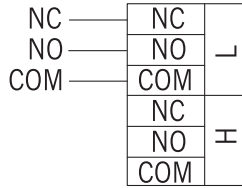

DPDT Wire Drawing DPDT 接線圖

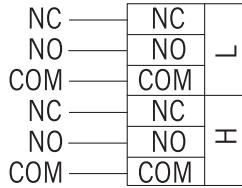

Micro Switch Data:

Switch Original Maker: HONEYWELL

Switch Data: One SPDT & Two SPDT Micro Switch, 15 amps 125/250V, Gold Contact Micro Switch 1A, 125/250VAC.

微動開關功率詳細資料：

製造商:HONEYWELL

內容規格:1 SPDT & 2 SPDT微動開關

電氣規格:15 amps 125/250V, Gold Contact Micro Switch 1A, 125/250VAC.

Sensitive Repeatability 精敏度重複性

Skills for the set point as follows:

The pressure continues 4 cycles should be operating up to set point, and return to low or high pressure point by request.

Ex.:

1. Code 20R- 35~200psi, Set Point 100psi Up ON

The pressure operateds from "0"psi up to set point 100psi micro switch working at ON. Then return to "0" continued 4 cycles to establish sensitive repeatability.

2. Code 20R- 35~200psi, Set Point 100psi Down ON

The pressure operateds up to 200psi, then down to 100psi switch working at ON. Then return to 200psi continued 4 cycles to establish sensitive repeatability.

設定點操作說明如下：

壓力持續4個循環後操作至設定點，之後依照要求返回至低壓或是高壓。

例如：

1. 代碼20R- 35~200psi，設定點100psi ▲開

從"0"psi操作壓力至設定點100psi，微動開關在「開」的狀態，然後轉回"0"，重複4個循環以建立其精敏度。

2. 代碼20R- 35~200psi，設定點100psi ▼開

操作至200psi後回到100psi，微動開關在「開」的狀態，之後再轉至200psi，重複4個循環以建立其精敏度。

3.0 CABLE GLAND INSTALLATION

Cable & Notice Items 配線及注意事項

- The explosion proof type cable gland should be used the certificated product with conformed O.D.
- Always remember to turn off the general power before the wiring to avoid an accident of electric shock.
- Before the wiring, please confirmed the safe condition- no dangerous, no flammable gas.
- In accordance with the regulatoins about connecting the cable with the electrical wire, the cable O.D corresponding to the different mateirals are as follows: (unit=mm)

C.R.	C20	C25	C32	C40	C45
Chlorprene Rubber (min. temp. -20°C)	6~8	10~12	16~18	22~24	28~30
	8~10	12~14	18~20	24~26	30~32
	10~12	14~16	20~22	26~28	32~34

- 防爆電纜封函蓋應使用符合電纜外徑之型式檢定合格品。
- 配線前必須先關閉總電源以避免電擊。
- 配線前需確認環境並無危險易燃氣體，方可施工。
- 依配電工法規將電源線與電器電線連接，不同材質的電纜對應之外徑(O.D)如下：(單位=mm)

C.R.	C20	C25	C32	C40	C45
Chlorprene Rubber (min. temp. -20°C)	6~8	10~12	16~18	22~24	28~30
	8~10	12~14	18~20	24~26	30~32
	10~12	14~16	20~22	26~28	32~34



Cable Gland Installation 電纜封函蓋安裝

After packing the cable gland, the inner Chlorprene (C.R.) rubber gasket is no longer repeat using. And, when the reinstall, Do Not pack the same section of packed cable, please pack the new section of cable. Please apply the Thread Sealants to the screw of housing case before assemble the cable gland.

防爆電纜封函蓋，在迫緊使用過後，內部之橡膠墊圈不可再重覆使用。且再安裝時，不可迫緊相同之電纜區段，要選擇未曾迫緊過的電纜區段。

防爆電纜封函蓋與電器殼體配合之螺孔，安裝前應塗抹適量的螺紋密封劑。

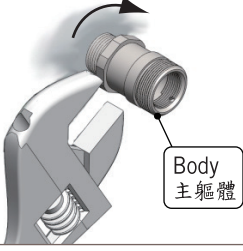
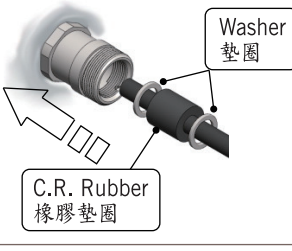
Cable Gland Assembly illustration 電纜封函蓋組裝解說

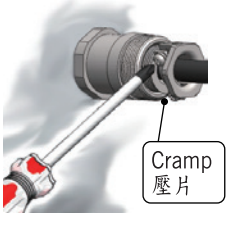
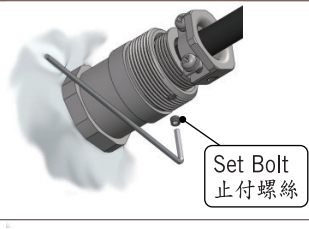
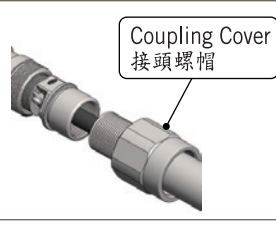
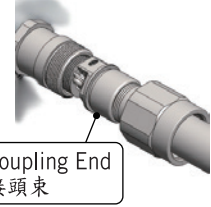
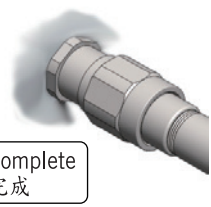
Step 1.	Step 2.
 <p>Body 主軀體</p>	 <p>Washer 墊圈 C.R. Rubber 橡膠墊圈</p>
<p>Use the wrench to screw the cable gland body to the conduit of housing case. 使用扳手將電纜封函蓋的主軀體旋入電器外殼的配接螺孔。</p>	<p>Set the cable into the C.R. rubber packing, and install in the body of cable gland. 將電纜套入橡膠墊圈中，並安裝於主軀體。</p>
Step 3.	Step 4.
 <p>Gland 迫緊栓</p>	 <p>Cramp 壓片</p>
<p>Set finished, use the tool tighten the gland, and then should back a half circle to keeping the C.R. rubber flexibility. 裝妥後使用工具拴上迫緊栓，拴至最緊時應退半圈，保持橡膠彈性。</p>	<p>Use the screwdriver to tighten the screws between the both sides of cramp, and fix the cable not to loose. 接著，使用螺絲起子將電纜壓片兩端的螺絲旋緊，確實壓持電纜，不致鬆動。</p>
Step 5.	Step 6.
 <p>Set Bolt 止付螺絲</p>	 <p>Coupling Cover 接頭螺帽</p>
<p>Use the hex-wrench to screw the set bolt to tight slightly. 上述動作完成後，方得使用工具鎖止止付螺絲，並旋至略緊即可。</p>	<p>Put the coupling cover into the wire ducts. 將接頭螺帽套入對接的導線管槽。</p>
Step 7.	Step 8.
 <p>Coupling End 接頭束</p>	 <p>Complete 完成</p>
<p>Connect the coupling end with the outer piping. 將接頭束與外部之管路連接。</p>	<p>Set the union nut into the body and fasten the screw to complete the assembling. 最後將由令螺帽套至主軀體之外螺牙處旋緊即完成。</p>

NOTE.

Step 6~8: for coupling type only.
接頭型式請參考步驟6~8。



Golden Mountain Enterprise Co., Ltd.

No. 9 Lane 133, Xing-Hua St., Chien-Chen Dist., Kaohsiung City, Taiwan

TEL: 886-7-8135500 FAX: 886-7-8225588

Email: info@new-flow.com

<http://www.new-flow.com>