

# DIAPHRAGM PRESSURE REGULATORS

## DRV-10

The DRV-10 is a LOW pressure regulating valve that is suitable for pressure control of air, gas, constant outlet pressure between 50 and 6000mmH<sub>2</sub>O.

### Technical Data

- Outlet Pressure** 50 to 6000 mmH<sub>2</sub>O; **Flow Rate** 30 to 1000 SLM.
- Adjustable Outlet Pressure Range and Max. Flow Rate:** please refer to the *Curve Table*
- Inlet Pressure:** 6 kg/cm<sup>2</sup> (87 psig)
- Body Material:** CF8M
- Diaphragm Material:** NBR + PTFE foil
- Seat Material:** Viton
- Plug & Trim Material:** SS316
- Operating Temperature:** -20°C to +60°C
- Process Connection:** Inlet: ½" NPT & ½" BSP female;  
Outlet: ¾" NPT & ¾" BSP female available



### Dimensions

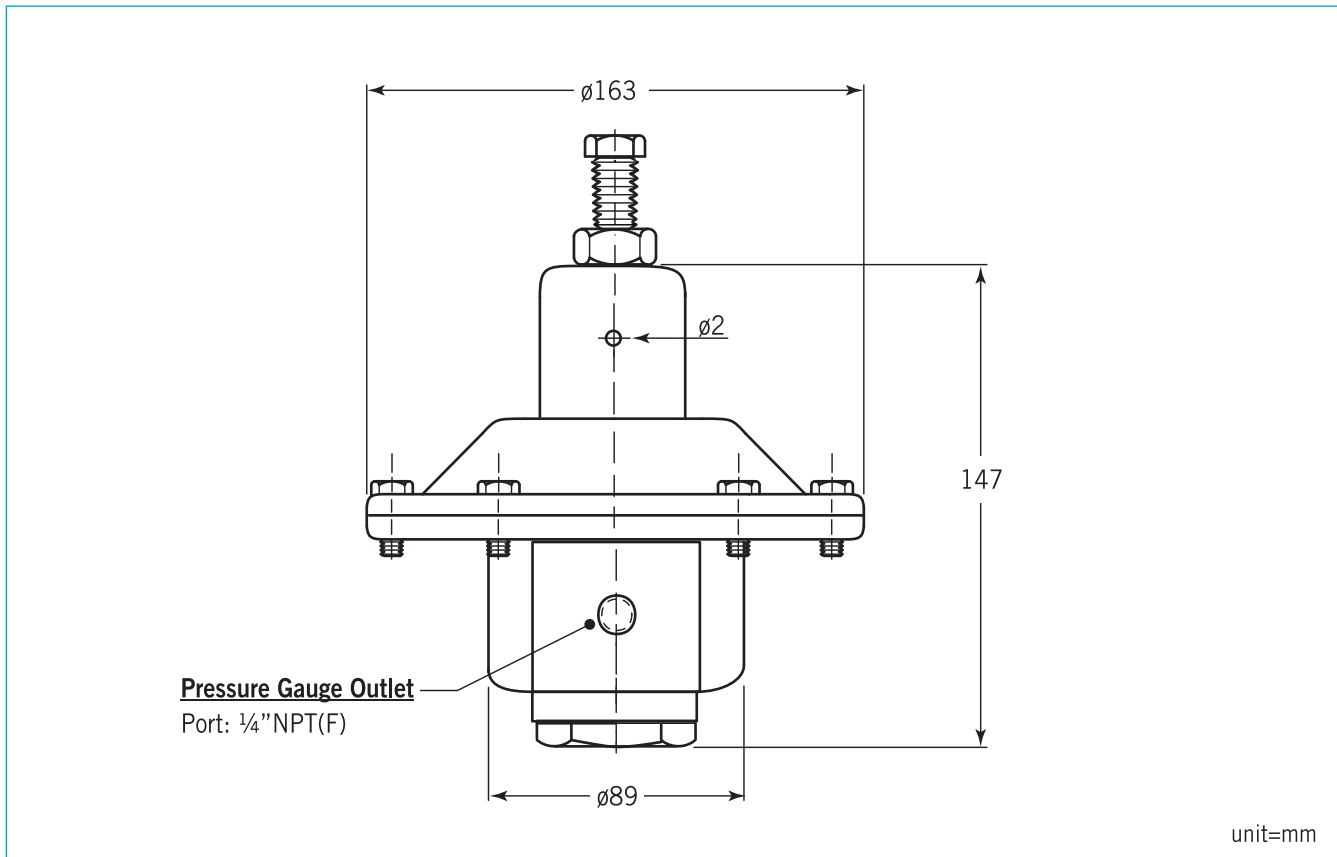

## Curve Table: Pressure (mmH<sub>2</sub>O) / Flow Rate (SLM)

Fluid: Air

### Spring A

Outlet: 50~600 mmH<sub>2</sub>O  
Bore Size: 5.6 mm  
Inlet Pressure: 2 kg/cm<sup>2</sup>

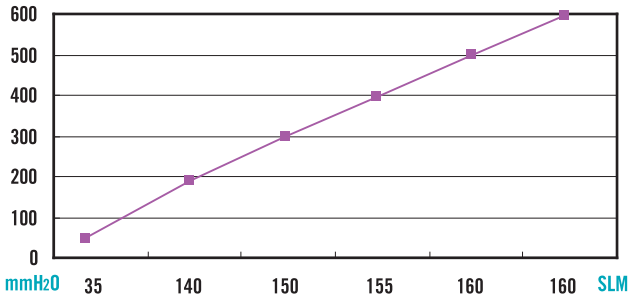

### Spring B

Outlet: 250~2000 mmH<sub>2</sub>O  
Bore Size: 5.6 mm  
Inlet Pressure: 2 kg/cm<sup>2</sup>

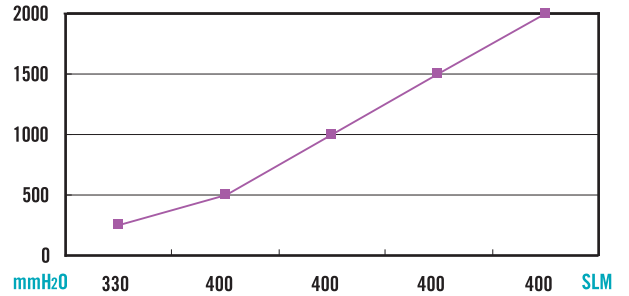

Outlet: 100~600 mmH<sub>2</sub>O  
Bore Size: 5.6 mm  
Inlet Pressure: 3 kg/cm<sup>2</sup>

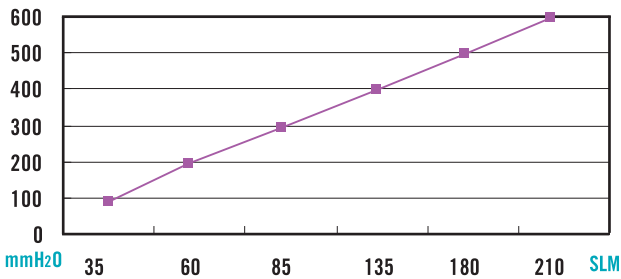

Outlet: 250~2000 mmH<sub>2</sub>O  
Bore Size: 5.6 mm  
Inlet Pressure: 3 kg/cm<sup>2</sup>

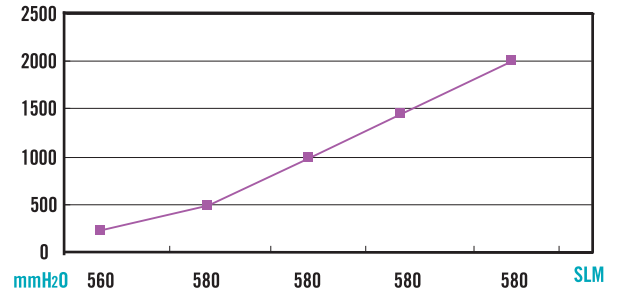

Outlet: 100~600 mmH<sub>2</sub>O  
Bore Size: 5.6 mm  
Inlet Pressure: 4 kg/cm<sup>2</sup>

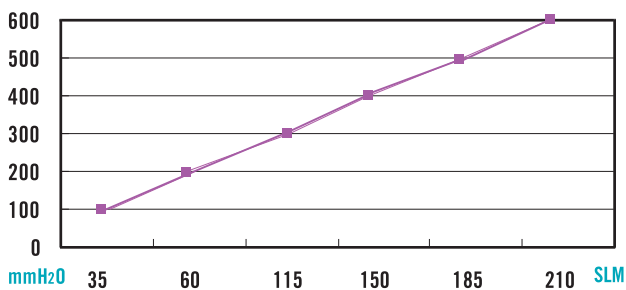

Outlet: 250~2000 mmH<sub>2</sub>O  
Bore Size: 5.6 mm  
Inlet Pressure: 4 kg/cm<sup>2</sup>

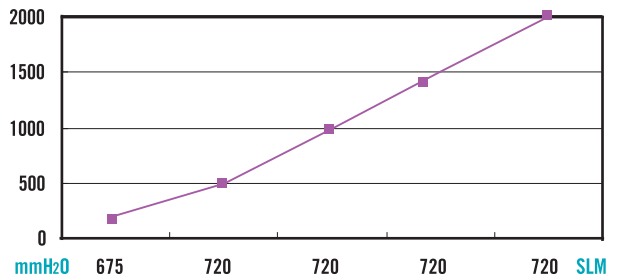

**Curve Table: Pressure (mmH<sub>2</sub>O) / Flow Rate (SLM)**

**Fluid: Air**

**Spring C**

Outlet: 400~4000 mmH<sub>2</sub>O  
Bore Size: 5.6 mm  
Inlet Pressure: 2 kg/cm<sup>2</sup>

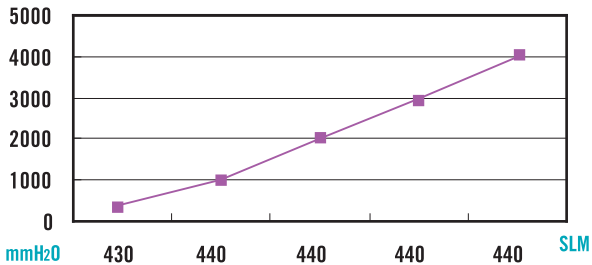

Outlet: 400~4000 mmH<sub>2</sub>O  
Bore Size: 5.6 mm  
Inlet Pressure: 5 kg/cm<sup>2</sup>

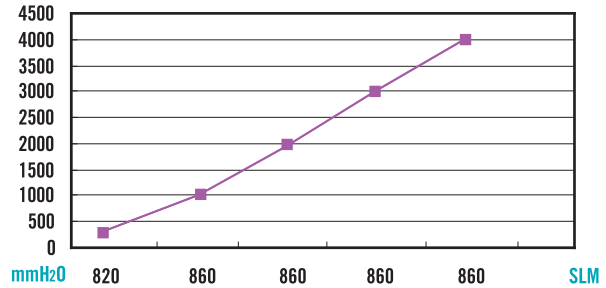

Outlet: 400~4000 mmH<sub>2</sub>O  
Bore Size: 5.6 mm  
Inlet Pressure: 3 kg/cm<sup>2</sup>

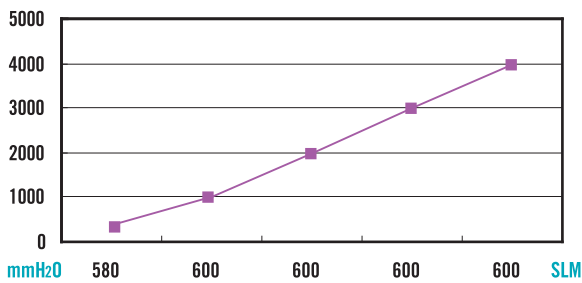

Outlet: 400~4000 mmH<sub>2</sub>O  
Bore Size: 5.6 mm  
Inlet Pressure: 6 kg/cm<sup>2</sup>

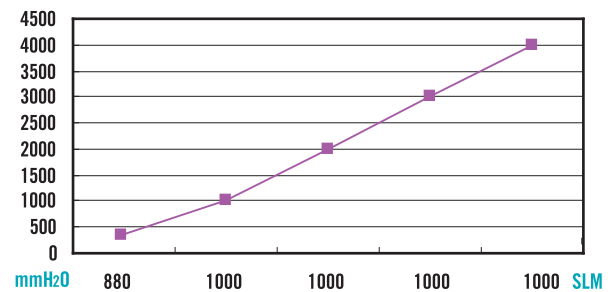

Outlet: 400~4000 mmH<sub>2</sub>O  
Bore Size: 5.6 mm  
Inlet Pressure: 4 kg/cm<sup>2</sup>

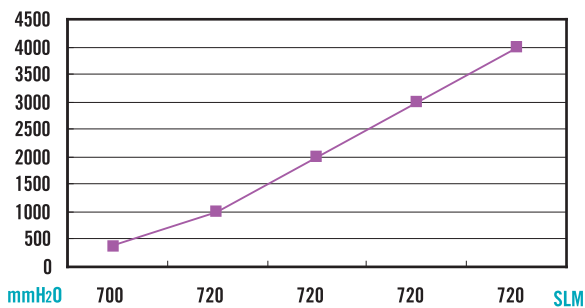

## Curve Table: Pressure (mmH<sub>2</sub>O) / Flow Rate (SLM)

Fluid: Air

### Spring D

Outlet: 1000~6000 mmH<sub>2</sub>O  
Bore Size: 5.6 mm  
Inlet Pressure: 4 kg/cm<sup>2</sup>

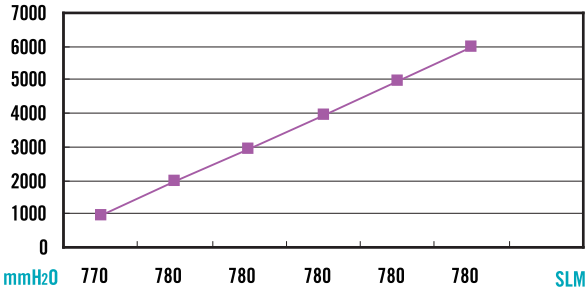

Outlet: 1000~6000 mmH<sub>2</sub>O  
Bore Size: 5.6 mm  
Inlet Pressure: 6 kg/cm<sup>2</sup>

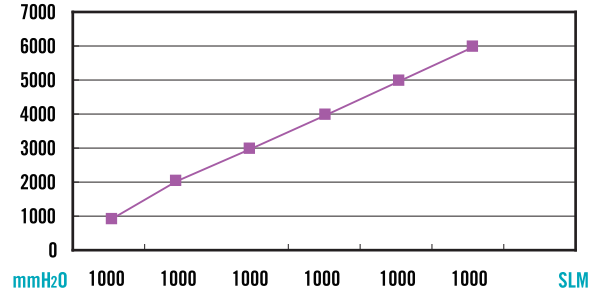

Outlet: 1000~6000 mmH<sub>2</sub>O  
Bore Size: 5.6 mm  
Inlet Pressure: 5 kg/cm<sup>2</sup>

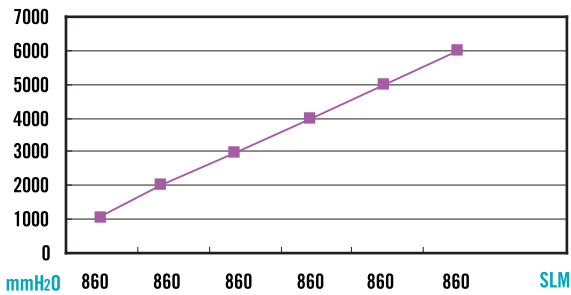

WWW.NEW-FLOW.COM • TEL: 886-7-8135500 • FAX: 886-7-8225588 • Email: info@new-flow.com

## Ordering Information

<b>DRV-10</b>	<b>Code</b>	<b>Instrument Connection (Female) Inlet x Outlet</b>
		(A) ½"NPT(F) x ¾"NPT(F) (B) ½"BSP(F) x ¾"BSP(F)
	<b>Code</b>	<b>Diaphragm Material</b>
	A	NBR + PTFE foil
	<b>Code</b>	<b>Spring Range</b>
		(A) 50~600 mmH <sub>2</sub> O (B) 250~2000 mmH <sub>2</sub> O (C) 400~4000 mmH <sub>2</sub> O (D) 1000~6000 mmH <sub>2</sub> O
	<b>Code</b>	<b>Body Material</b>
	A	CF8M
<b>DRV-10</b>		<b>Complete Ordering Code</b>