

Marine Grade Switches

YTK CO.,LTD.

Http://www.ytk-group.co.jp

Weather-proof switches specially designed for outdoor environments

Large Current (20A) Anti-Vandal Stainless Steel Push-Button Switch with LED Ring

PB-44xx Series - with LED light ring

PB-45xx Series - with backlight labels

PATENTED
US,TW,CH



PB4411TB



PB4411TR



PB4511TB



PB4511TR

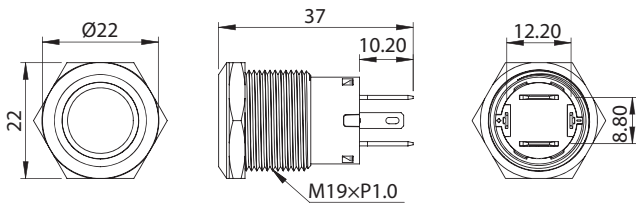

Product Series		
Product ID	Voltage Rating	Switch Function
PB-4411TL-X	DC 12V	ON-OFF (Latching)
PB-4511TL-X		
PB-4411T-X	DC 12V	(ON)-OFF (Momentary)
PB-4511T-X		
PB-4411TL-X-24V	DC 24V	ON-OFF (Latching)
PB-4511TL-X-24V		
PB-4411T-X-24V	DC 24V	(ON)-OFF (Momentary)
PB-4511T-X-24V		

※ X Stands for Symbol illumination LED color.
R : Red / B : Blue / W : White / G : Green

Features

- Market-leading 20A Capability (No more relays!)
- Same compact size as mainstream anti-vandal switches in market (PB-42 Series)
- Durable CNC Stainless Steel (SS316) housing
- 0.250" Quick connect terminals
- LED light rings configurable to be push-on (power indication) or always on (back lighting)
- IP67 – protected even under temporary water immersion

Additional Features for PB45xx

- Backlight button version
- 5 pcs PC membrane label stickers included
- Additional 40pcs assorted label stickers sold separately (PB-ST-1)



5 pcs labels included with PB45xx series

Specifications

- Rating | DC 12V 20A / DC 24V 10A
- Electrical Life | > 20,000 cycles
- Operation Temperature | -20°C ~ +55°C
- Note | Patented in Taiwan(M558458) & China(ZL2018202565058) & USA(US10297404B1)

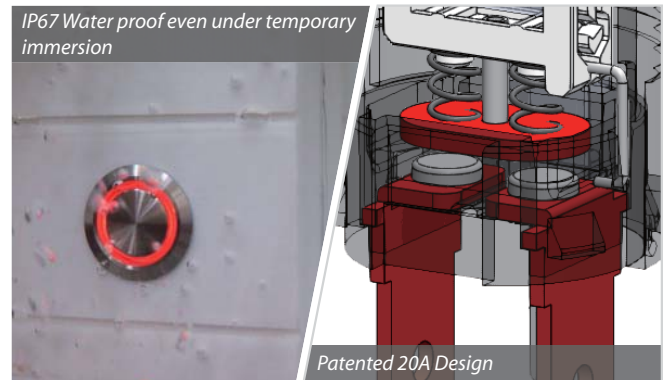

Label stickers for PB45xx Series

PB-ST-1



- 40 pcs assorted label sticker
- Scratch resistant, water-proof PC membrane material
- Customized version also possible
- Back printing for better durability

*This product is under development, all specifications and features are subject to change. Contact sales for final specs.

Anti-Vandal Stainless Steel Push-Button Switch with LED Ring
 PB-42xx Series

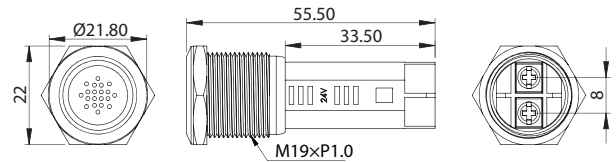
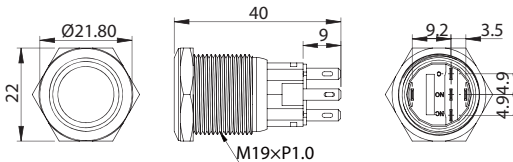

Product Series			
Product ID	Voltage Rating	LED Color	Switch Function
PB-4212TL-R	DC 12V	Red	ON-OFF (Latching)
PB-4212T-R	DC 12V	Red	(ON)-OFF (Momentary)
PB-4212TL-B	DC 12V	Blue	ON-OFF (Latching)
PB-4212T-B	DC 12V	Blue	(ON)-OFF (Momentary)
PB-4212TL-R-24V	DC 24V	Red	ON-OFF (Latching)
PB-4212T-R-24V	DC 24V	Red	(ON)-OFF (Momentary)
PB-4212TL-B-24V	DC 24V	Blue	ON-OFF (Latching)
PB-4212T-B-24V	DC 24V	Blue	(ON)-OFF (Momentary)
PB-BZ-1R	DC 12V	Red/flashing	Buzzer

- Up to Double Pole NO/NC/COM Terminals (5 or 8 Terminals)
- Durable stainless steel housing and button
- LED light rings configurable to be push-on (power indication) or always on (back lighting).
- IP67 – protected against even under temporary water immersion (IP50 for the Buzzer PB-BZ-1R)

Specifications

- Rating | DC 12V 5A / DC 24V 5A
- Electrical Life | > 50,000 cycles
- Operation Temperature | -20°C ~ +55°C

Starter Push-Button Switch
 PB-4071

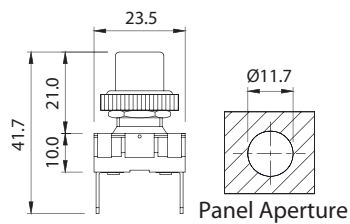

Features

- Quick terminal blades
- High current push button switch
- Water-resistant cap available
- Rating: AC 125V 15A / 240V 10A

Rubber Boot
 PB-RB-1



PATENTED
 TW,CH

IP67 Water-resistant Sealed Rocker Switch
 C-7 Series

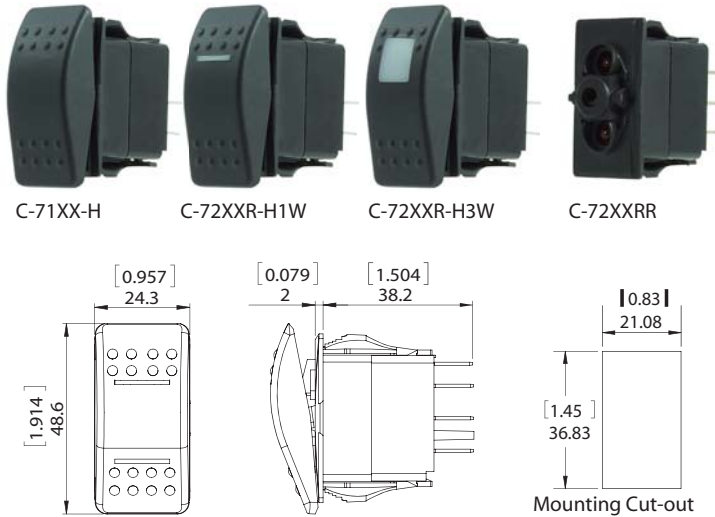

Product Series		
Product ID	Type	Switch Function
C-7124	SPST	(ON)-OFF
C-7137	SPDT	(ON)-OFF-(ON)
C-7144	DPST	(ON)-OFF
C-7167	DPDT	(ON)-OFF-(ON)
C-7231R	SPST	ON-OFF
C-7251R	DPST	ON-OFF
C-7243RR	SPDT	ON-OFF-ON
C-7273RR	DPDT	ON-OFF-ON
C-7246RR	SPDT	(ON)-OFF-ON
C-7276RR	DPDT	(ON)-OFF-ON
C-7272RR	DPDT	ON-ON

※ Product ID are for Switch Body only, for full switch with actuators, add suffix like "-H1W" (see Website)



Features

- Fit popular Contura style switch mounting
- Interchangeable actuators with various options
- Available in customized switch function, illuminating and other configurations
- LED illuminated (DC12V/ 24V dual voltage)
- PC Terminals (0.250" Quick Connect Terminals)
- IP67: Water proof even under temporary water immersion
- Exclusive advanced water-tight sealing design (Patented)



IP67 Water proof even under temporary water immersion

Specifications

- Rating | DC 12V 20A 24V 10A
- Electrical Life | 20,000~50,000 switch function dependent
- Note | IP67 Patented in TW CH



Advanced water-tight sealing design (Patented)

Actuator Removal Tool for C-7 Switches
 C7-RM-1

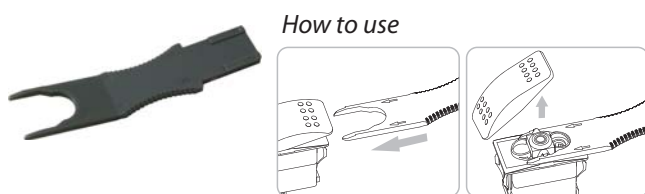

- Used to change C-7 switch actuators
- Anti-slip grip design

Hole Cover
 C7-HC-1



Actuator for C-7 Switch

C7A-XXX

※ Check coding guide online:
http://tiny.cc/C7_Actuator



C7A-H1W C7A-H3W C7A-H3R-25

- Available stand-alone without switch body
- Available in various colors, lens configurations and printing options
- Lens color available in white, red, amber, green and blue
- Customizable silkscreen printing or label stickers on square lens available

Laser Etched Contour C-7 Actuator

C-7251XYS ON-OFF
C-7254XYS (ON)-OFF

PATENTED
TW,CH

※ Check full patterns online:
http://tiny.cc/C-7_Laser_Actuators



- Premium feeling and backlight effects
- YIS exclusive trendy actuator shape (Patented)
- Laser etching technology allowing even very complicated patterns
- Illuminates on both symbol and label (label illumination configurable to be always on or power indication)
- 100% customizable with low MoQ

※ X Stands for Symbol illumination LED color, and Y for Label LED Color (X is ON only when switch is ON; Y is configurable externally.)

Mounting Panel for C-7 Series

C7-PA-1 (End Frame)
C7-PA-2 (Middle Frame)



- Allows mounting of multiple switches together
- Cascade as many switches as you like
- Push-in installations

Label Stickers for C-7 Switch with square lens

C7-ST-1



- 60 pcs assorted label stickers
- For use with Actuators with white square lens C7A-H3W
- Sold separately



Digital Battery Gauges – Switch Mount

SP-BG4 Digital Voltmeter
SP-BG5 Digital Voltage & Current Dual-meter



※ Fit popular Contura style switch mounting (See page 56-57)

High Power 2 Port USB Charger – Switch Mount

AS235 (2.4A + 1A)
AS235-4.8A (2.4A + 2.4A)

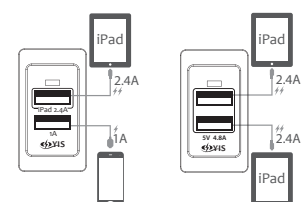

AS235

AS235-4.8A

※ Fit popular Contura style switch mounting (See page 60)

IP55 Water-resistant Rocker Switch
C-61/C-62 Series

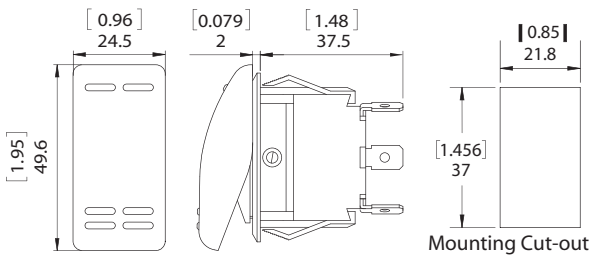

Product Series		
Product ID	Type	Switch Function
C-6124P	SPST	(ON)-OFF
C-6136P	SPDT	(ON)-OFF-ON
C-6137P	SPDT	(ON)-OFF-(ON)
C-6144P	DPST	(ON)-OFF
C-6166P	DPDT	(ON)-OFF-ON
C-6167P	DPDT	(ON)-OFF-(ON)
C-6231P	SPST	ON-OFF
C-6253P	SPDT	ON-OFF-ON

Features

- Robust design to withstand outdoor environments
- Easy-to-press, stylish curved actuator design
- Available in various switch functions and illuminating configurations
- PC Terminals (0.250" Quick Connect Terminals) or Screw Terminals
- LEDs or Lamps available for illuminated C-62 series
- IP55 : Water projected in jets from any direction shall have no harmful effects

Specifications

- Rating | DC 12V 16A 24V 10A
- Electrical Life | 20,000 make and break cycles at full load

Mounting Panel for C-6 Series



Toggle Switch
C-65/C-66 Series

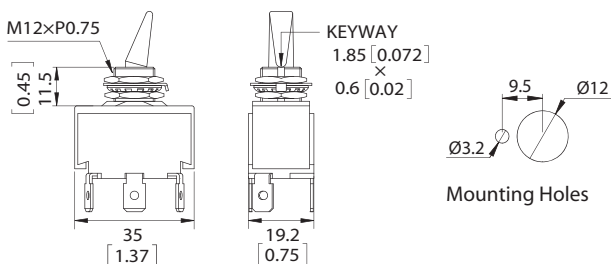

Features

- Available in various switch functions, illuminating and other configurations
- Current rating up to 16A (@12V DC)
- Self-illuminating handle bar (C-66 only)
- Heat-resistant bakelite switch body
- Available in PC (Quick) Terminals or Screw Terminals
- Hidden color lens allowing up to three different illuminating colors(for illuminated C-66 series)

Specifications

- Rating | DC 12V 16A 24V 10A
- Electrical Life | 20,000 make and break cycles at full load

Product Series		
Product ID	Type	Switch Function
C-6521P	SPST	ON-OFF
C-6524P	SPST	(ON)-OFF
C-6537P	SPDT	(ON)-OFF-(ON)
C-6631P ☀	SPST	ON-OFF
C-6634P ☀	SPST	(ON)-OFF
C-6647P ☀	SPDT	(ON)-OFF-(ON)

Rubber Boot C6-RB-2



- Water-proof, dust proof rubber boot
- Screw Nuts: M12
- Available in clear/black color

C6653L-CRG:Tri-color illuminated switch ON-OFF-ON



Heavy-Duty Toggle Switch T-13 Series



T-1325P / T-1327P

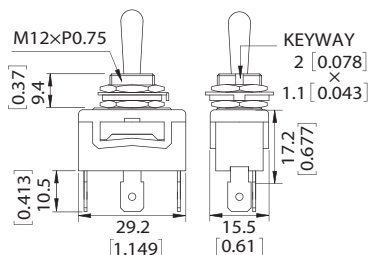

Features

- Current rating up to 15A (@12V DC)
- Robust and durable toggle design
- Available in PC (Quick) Terminals or Screw Terminals
- Series-specific nameplates and rubber boot available
- Short Body design saves mounting space (for T-1331 series)

Specifications

- Rating | DC 12V 15 A 24V 10A
- Electrical Life | 50,000 make and break cycles at full load



T-1330P

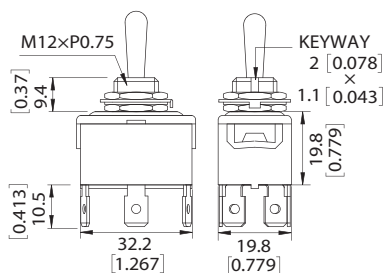

T-1331P

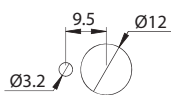
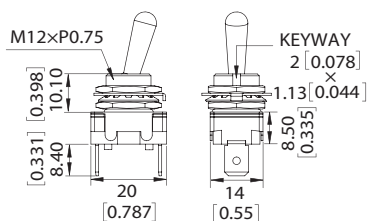

Mounting Holes

Rubber Boot T-RB-3



- Water-proof, dust proof rubber boot
- Screw Nuts: M12
- Available in clear/black color