

Z-D003

Modern LED Interior Light

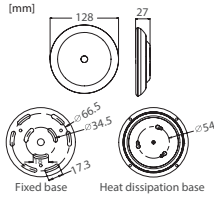

Item No.	Z-D003
Touch Button	With
Lamp Housing	O
LED Q'TY (PCS)	121
Input Voltage	12-24V
Power Consumption (W)	6.5
Color Temperature	2700K/5500K
Function	Reading light
Compliance	ECE R10



Z-D02 Series

Modern LED Interior Light



Item No.	Z-D023	Z-D024	Z-D025	Z-D026
Touch Button	With	With	No	No
Lamp Housing	O	●	O	●
LED Q'TY (PCS)	41	41	40	40
Input Voltage	12-24V			
Power Consumption (W)	5			
Color Temperature	2700K/5500K			
Function	Reading light			
Compliance	ECE R10			

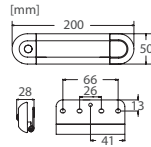

Bracket movable

Z-D03 Series

Modern LED Interior Light



Item No.	Z-D033	Z-D034	Z-D035	Z-D036
Touch Button	With	With	No	No
Lamp Housing	O	●	O	●
LED Q'TY (PCS)	73	73	72	72
Input Voltage	12-24V			
Power Consumption (W)	8			
Color Temperature	2700K/5500K			
Function	Reading light			
Compliance	ECE R10			

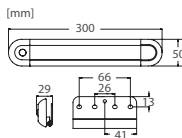

Bracket movable



CM-20 SERIES

SWITCH WORK LIGHT WITH **OVER-HEATED PROTECTED**

ECE R10	High Luminance Chip
CE	IP67
RoHS	OSRAM

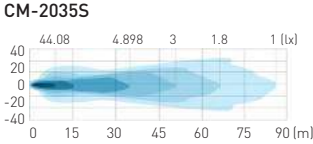

Item No.	Beam Pattern	Wattage	LED CHIP	LED Quantity	Effective Lumen
CM-2020R	Flood	20W	OSRAM	4Pcs	1600LM
CM-2020S	Flood	20W	OSRAM	4Pcs	1600LM
CM-2035R	Flood	25W(79°C)-42W(30°C)	OSRAM	9Pcs	2800-3800LM
CM-2035S	Flood	25W(79°C)-42W(30°C)	OSRAM	9Pcs	2800-3800LM
CM-2090S	Flood	30W(79°C)-50W(30°C)	OSRAM	16Pcs	2800-4000LM

- Voltage: 10-30V - Housing Material: Aluminum - Bracket Material: Stainless Steel

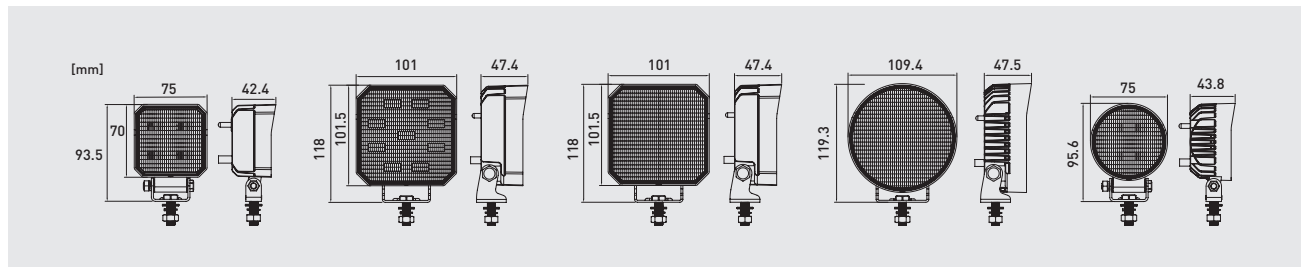

CM-20 PLUS SERIES

UPGRADED SWITCH WORK LIGHT WITH **OVER-HEATED PROTECTED**

ECE R10

 High Luminance Chip

CE

 IP67

 RoHS

OSRAM

- NEW UPGRADE FLOOD LENS , ENSURE A WIDE RANGE OF LIGHT SPREAD , MORE SUITABLE FOR AGRICULTURE WORKING
- SWITCH ON THE BACK , CONVINENT FOR ON/OFF
- SAME SIZE AS CM-20 SERIES

4.5"



CM-2035R PLUS

4"



CM-2035S PLUS

4"



CM-2090S PLUS

NEW

Item No.	Beam Pattern	Wattage	LED CHIP	LED Quantity	Raw Lumen	Effective Lumen
CM-2025R PLUS	Flood	15W	OSRAM	9Pcs	1500LM	1100LM
CM-2035S PLUS	Flood	15W	OSRAM	9Pcs	1500LM	1100LM
CM-2090S PLUS	Flood	25W	OSRAM	16Pcs	2000LM	1600LM

- Voltage: 10-30V - Housing Material: Aluminum - Bracket Material: Stainless Steel

[mm]

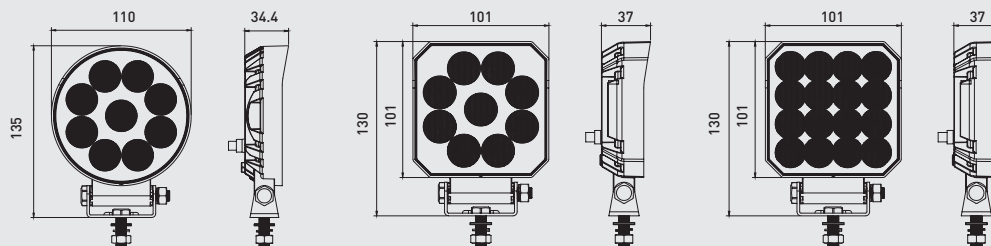

CM-7882 / CM-7883

LED HEAVY DUTY AGRICULTURE WORK LIGHT

ECE R10

 High Luminance Chip

CE

 IP67 & IP69K

 RoHS

OSRAM



NEW



CM-7882



CM-7883

304 Stainless Steel

Item No.	Beam Pattern	Wattage	LED CHIP	LED Quantity	Raw Lumen	Effective Lumen
CM-7882	Flood	43W	OSRAM	9Pcs	5200LM	4000LM
CM-7883	Flood	43W	OSRAM	9Pcs	5200LM	4000LM

- Voltage: 10-30V - Housing Material: Aluminum - Bracket Material: 304 Stainless Steel

[mm]

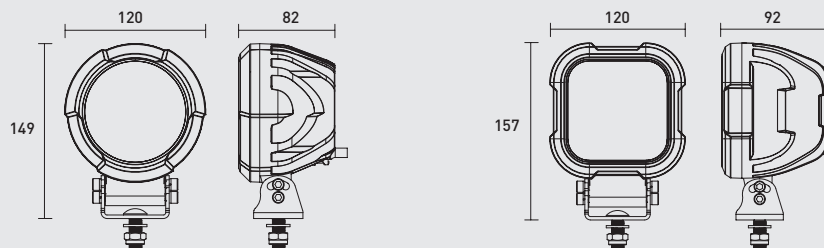

YTK CO.,LTD.
[Http://www.ytk-group.co.jp](http://www.ytk-group.co.jp)

CM-2046 LED AGRICULTURE WORK LIGHT

IP67 | ECE R10 | CE | RoHS | High Luminance Chip

Item No.	CM-2046
Beam Pattern	Flood
Wattage	46W
LED Q'TY (PCS)	9
LED CHIP	SMD
Voltage	10-30V
Effective Lumen	3100LM
Raw Lumen	4100LM
Compliance	ECE R10 RoHS

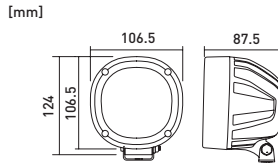

CM-6048 LED AGRICULTURE WORK LIGHT

IP67 | ECE R10 | CE | RoHS | High Luminance Chip

Item No.	CM-6048
Beam Pattern	Flood / Spot
Wattage	48W
LED Q'TY (PCS)	16
LED CHIP	SMD
Voltage	10-30V
Effective Lumen	2420LM
Raw Lumen	2800LM
Compliance	ECE R10 RoHS

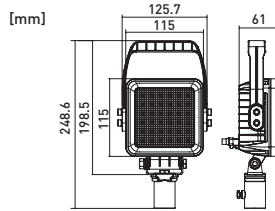

CM-3036 LED AGRICULTURE WORK LIGHT WITH OVER-HEATED PROTECTED

IP67 | ECE R10 | CE | RoHS | OSRAM | High Luminance Chip

Item No.	CM-3036
Beam Pattern	Flood
Wattage	35-41W
LED Q'TY (PCS)	12
LED CHIP	OSRAM
Voltage	10-30V
Lumen	3800-4500LM
Bracket Material	304 Stainless Steel
Compliance	ECE R10 RoHS

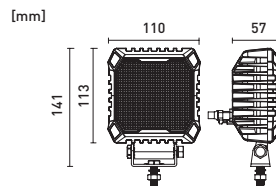

CM-7007

MUITFUNCTION FORKLIFT SAFE LIGHT

ECE R10

 High Luminance Chip

CE

 IP67

 RoHS



Item No.	Beam Pattern	Wattage	LED CHIP	LED Quantity	Effective Lumen	LED Color
CM-7007	White work light	10.5W	SMD	6Pcs	750LM	○
	Green spot warning light	5.5W	SMD	1Pcs	—	●
	Amber warning light	1.5W	SMD	6Pcs	—	●
	Rear, red warning light	1W	SMD	2Pcs	—	●
	Red line zone warning	6.5W	SMD	3Pcs	—	●

- Voltage: 10-80V - Housing Material: Aluminum - Lens Material: PC

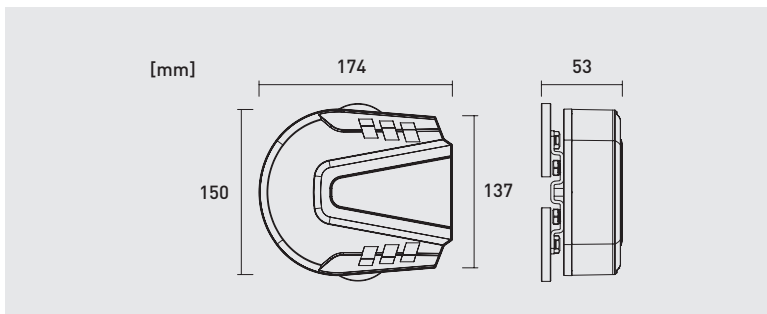

PRODUCT DISPLAY



LED REAR LAMP ECE R3 ECE R4 ECE R6 ECE R7 ECE R23 ECE R38 ECE R10 RoHS CE

Item No.	Picture	Function	Page
Z-T081		RPL DI ST Reflex	01
Z-T071		RPL DI ST Reflex	02
Z-T111		RPL DI ST Reverse RF Reflex	02
Z-T012 Z-T011		RPL DI ST Reflex	02
Z-T06		RPL DI ST Reverse RF Reflex NPL	03
Z-T10		RPL DI ST Reverse RF Reflex NPL	03
Z-T02		RPL DI ST Reflex	03
Z-T09		RPL DI ST Reverse RF Reflex NPL	04
Z-T26		RPL DI ST Reverse RF Reflex NPL	05

FPL: Front Position Lamp
RPL: Rear Position Lamp
DI: Direction Indicator Lamp

ST: Stop / Brake
Reverse: Reversing Lamp
RF: Rear Fog

Reflex: Reflex Reflector
NPL: Number plate light

LED REAR LAMP ECE R3 ECE R4 ECE R6 ECE R7 ECE R23 ECE R38 ECE R10 RoHS CE

Item No.	Picture	Function	Page
Z-T05		RPL DI ST Reverse RF Reflex NPL	04
Z-T151		European type RPL/ST/Reverse/ Reflex American type RPL/DI/ST/ Reverse/Reflex	07
Z-T36		RPL DI ST	07
Z-T22		RPL DI ST	08
Z-T001 Z-T002 Z-T003		 RPL DI RPL ST RPL Reverse	09
Z-T041		RPL DI ST	08
Z-T044		RPL DI ST Reverse	08
Z-T171 Z-T172 Z-T173		 DI ST Reverse	09

FPL: Front Position Lamp
RPL: Rear Position Lamp
DI: Direction Indicator Lamp

ST: Stop / Brake
Reverse: Reversing Lamp
RF: Rear Fog

Reflex: Reflex Reflector
NPL: Number plate light

YTK CO.,LTD.
Http://www.ytk-group.co.jp

LED REAR LAMP			
Item No.	Picture	Function	Page
Z-T29A		RPL ST	06
Z-T29B		RPL DI	06
Z-T29C		RPL Reverse	06
Z-T29D		RPL DI ST Reflex	06
Z-T29E		RPL ST Reverse Reflex	06
Z-T29F		RPL DI ST Reverse Reflex	06
Z-T30 Series		RPL DI ST Reflex NPL	10
Z-T30		RPL DI ST	10
Z-T30B		RPL DI ST	15

FPL: Front Position Lamp
RPL: Rear Position Lamp
DI: Direction Indicator Lamp

ST: Stop / Brake
Reverse: Reversing Lamp
RF: Rear Fog

Reflex: Reflex Reflector
NPL: Number plate light

LED FRONT/REAR LAMP			
Item No.	Picture	Function	Page
Z-T28 Wire		FPL DI Reflex	12
Z-T28 Wire		RPL DI ST Reflex NPL	12
Z-T28 Wireless		FPL DI Reflex	12
Z-T28 Wireless		RPL DI ST Reflex NPL	12
Z-T03 Wire		FPL DI Reflex	13
Z-T03 Wire		RPL DI ST Reflex NPL	13
Z-T03 Wireless		FPL DI Reflex	13
Z-T03 Wireless		RPL DI ST Reflex NPL	13

FPL: Front Position Lamp
RPL: Rear Position Lamp
DI: Direction Indicator Lamp

ST: Stop / Brake
Reverse: Reversing Lamp
RF: Rear Fog

Reflex: Reflex Reflector
NPL: Number plate light

YTK CO.,LTD.
[Http://www.ytk-group.co.jp](http://www.ytk-group.co.jp)

LED FRONT/REAR LAMP



Item No.	Picture	Function	Page
Z-T212		RPL DI ST NPL	15
Z-T43		RPL DI ST RF NPL Reflex	14
Z-T43		RPL DI ST RF NPL Reflex	14
Z-TL01		--	15
Z-T191		FPL DI	17
Z-T193		RPL DI ST	17
Z-T201		FPL DI	17
Z-T203		RPL DI ST	17

FPL: Front Position Lamp
RPL: Rear Position Lamp
DI: Direction Indicator Lamp

ST: Stop / Brake
Reverse: Reversing Lamp
RF: Rear Fog

Reflex: Reflex Reflector
NPL: Number plate light

LED WARNING LAMP



Item No.	Picture	Modes	Page
Z-W08B		 3 modes flash 4 modes rotation	19
Z-W08S		 3 modes flash 4 modes rotation	19
Z-W08M		 3 modes flash 4 modes rotation	19
Z-W08P		 3 modes flash 4 modes rotation	19
Z-W09B		 3 modes flash 4 modes rotation	20
Z-W09S		 3 modes flash 4 modes rotation	20
Z-W09M		 3 modes flash 4 modes rotation	20
Z-W09P		 3 modes flash 4 modes rotation	20
Z-W10		 4 modes flash 4 modes rotation	23

LED WARNING LAMP



Item No.	Picture	LED Colour / Modes	Page
Z-W16B		3 modes flash 4 modes rotation	21
Z-W16S		3 modes flash 4 modes rotation	21
Z-W16M		3 modes flash 4 modes rotation	21
Z-W16P		3 modes flash 4 modes rotation	21
Z-W15B		3 modes flash 4 modes rotation	22
Z-W15S		3 modes flash 4 modes rotation	22
Z-W15M		3 modes flash 4 modes rotation	22
Z-W15P		3 modes flash 4 modes rotation	22
Z-W13S		5 modes flash 2 modes rotation	23

LED WARNING LAMP



Item No.	Picture	LED Colour / Modes	Page
Z-W13S		3 modes flash 4 modes rotation	23
Z-W13P		3 modes flash 4 modes rotation	23
Z-W47S		3 modes flash 3 modes rotation	24
Z-W47M		3 modes flash 3 modes rotation	24
Z-W47P		3 modes flash 3 modes rotation	24
Z-W02		Double flash	26
Z-W02		Double flash	26
Z-W02		Double flash	26
Z-W02		Double flash	26

LED WARNING LAMP				CISPR 25	SAE J845	ECE R65	ECE R10	RoHS	CE
Item No.	Picture	LED Colour / Modes	Page						
Z-W03		 4 modes flash	27						
Z-W04		 8 modes flash	27						
Z-W00		 4 modes flash	28						
Z-W01		 4 modes flash	28						
Z-W05		 10 modes flash	28						
Z-W24		 10 modes flash Steady on	29						
Z-W29		 Marker / Warning	29						
Z-W38S		 5 modes flash Position light	29						

LED WARNING LAMP				CISPR 25	SAE J845	ECE R65	ECE R10	RoHS	CE
Item No.	Picture	LED Colour / Modes	Page						
Z-W26		 4 modes flash (Red+Blue light) 4 modes flash 4 modes rotation 1 modes cruise (Amber light)	32						
Z-W27		 4 modes flash (Red+Blue light) 4 modes flash 4 modes rotation 1 modes cruise (Amber light)	32						
Z-W12B		 5 modes flash 2 modes rotation	31						
Z-W12M		 5 modes flash 2 modes rotation	31						
Z-W12D		 3 modes flash 4 modes rotation	31						

LED WARNING LAMP			
Item No.	Picture	LED Colour / Modes	Page
Z-W11M Z-W11S		● 8 modes flash	35
Z-W18		● ● ● 5 modes flash 5 modes rotation 1 cruise 3 modes arrow	33
Z-W45		● 6 modes flash 5 modes rotation 2 cruise 3 modes dynamic	37
Z-W25		● 3 modes flash 1 cruise 1 modes dynamic	39

MODERN LED INTERIOR LIGHT			
Item No.	Picture	Function	Page
Z-D003		Reading light	45
Z-D02		Reading light	45
Z-D03		Reading light	45

LED MARKER LAMP			
Item No.	Picture	LED Colour / Function	Page
Z-M141		● ● ○ SDMK Reflex	43
Z-M161		● ● ○ SDMK Reflex	43
Z-M19		● ● ○ SDMK Reflex DI	42
Z-M001		● ● SDMK FPL RPL	44
Z-M011		● ● ● ○ FPL RPL	44
Z-M061		○ NPL	44

FPL: Front Position Lamp
RPL: Rear Position Lamp

SDMK: Side Marker Lamp
Reflex: Reflex Reflector



NPL: Number plate light
DI: Direction Indicator Lamp

LED WORK LIGHT			
Item No.	Picture	Beam Pattern	Page
CM-2020R		Flood	47
CM-2020S		Flood	47
CM-2035R		Flood	47
CM-2035S		Flood	47
CM-2090S		Flood	47
CM-2035R PLUS		Flood	48
CM-2035S PLUS		Flood	48
CM-2090S PLUS		Flood	48



LED WORK LIGHT			
Item No.	Picture	Beam Pattern	Page
CM-2046		Flood	50
CM-7882		Flood	49
CM-7883		Flood	49
CM-6048		Flood / Spot	50
CM-3036		Flood	50



LED FORKLIFT SAFE LIGHT			
Item No.	Picture	LED Colour / Function	Page
CM-7007		 Work light Warning light Amber strobe light Line zone warning	51

