

# A1 Waterproof connector

## Applications:

- E-Bike
- E-Scooter
- Drone
- Vacuum Cleaner
- Energy storage battery
- electric lawn mower
- AGV



Male Connector

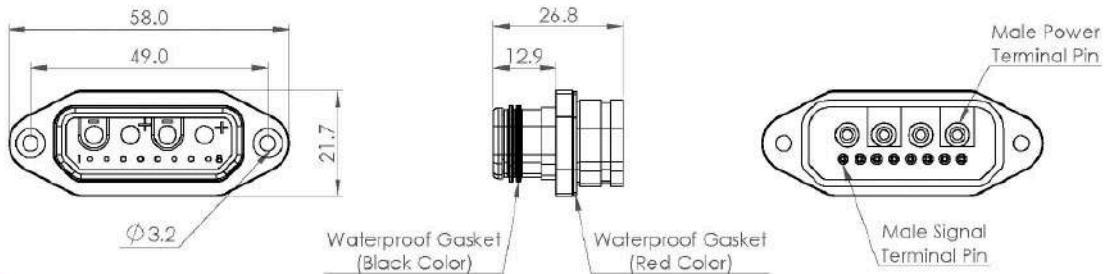

Female Connector

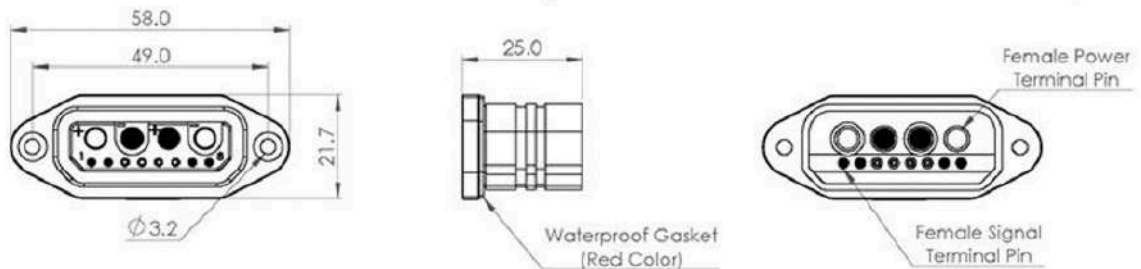

### Features

Terminal	2P4S ( MAX:4P8S ) PWR.Terminal 30A
Current withstand	(Instantaneous peak current 40A) Signal terminal 2A
IP rating	IP68
Material of housing	PBT+GF15% UL94 V0

### Wire Information

Wire Spec. for Standard Sample	
Wire Gauge	
Power Terminal	16AWG to 14AWG 12AWG to 10AWG
Signal Terminal	26AWG to 24AWG

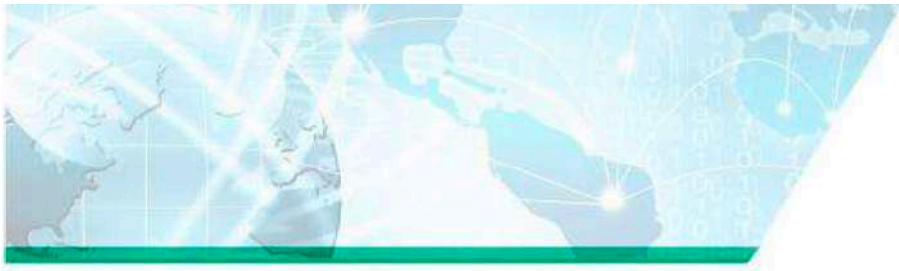

# A3 Waterproof connector

## Applications:

- E-Bike
- E-Scooter
- Drone
- Vacuum Cleaner
- Energy storage battery
- electric lawn mower
- AGV



Male Connector

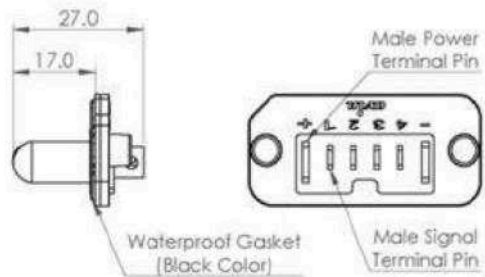
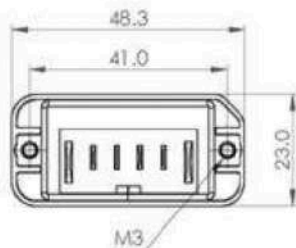

Female Connector

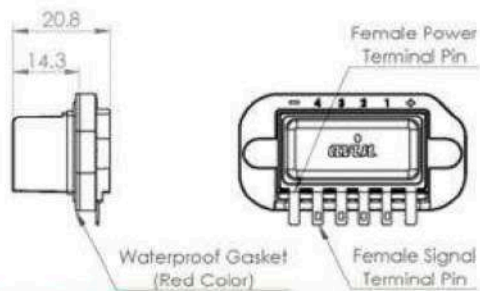
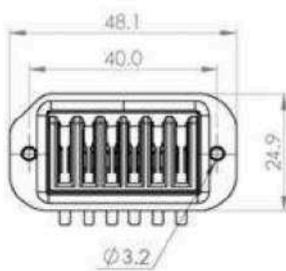

### Features

Terminal	2 PWR. pin & 4 SIG. pin
	PWR. Terminal 30A
Current withstand	(Instantaneous peak current 40A)
	SIG. Terminal 10A
IP rating	IP66
Material of housing	PBT+GF15% UL94 V0

### Wire Information

Wire Spec. for Standard Sample	
Wire Gauge	
Power Terminal	14AWG to 12AWG
Signal Terminal	24AWG to 22AWG

A3

Waterproof connector



# A7 Waterproof connector



Male Connector

## Applications:

- E-Bike
- E-Scooter
- Drone
- Vacuum Cleaner
- Energy storage battery
- electric lawn mower
- AGV

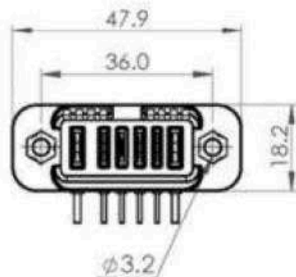

Female Connector

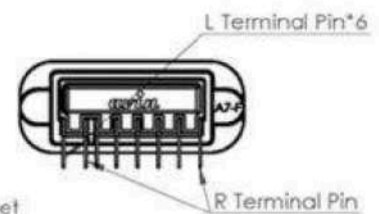
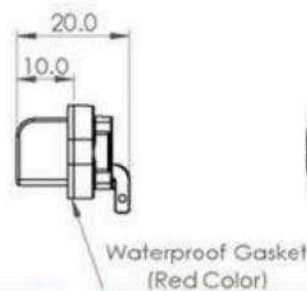
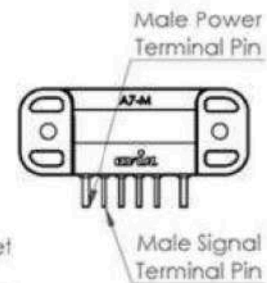
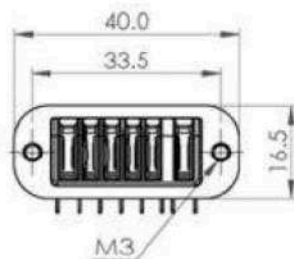

### Features

Terminal	2 PWR. pin & 4 SIG. pin
	PWR. Terminal 30A
Current withstand	(Instantaneous peak current 40A)
	SIG.Terminal10A
IP rating	IP66
Material of housing	PA66+15%GF UL94 V0

### Wire Information

Wire Spec. for Standard Sample	
Wire Gauge	
Power Terminal	10AWG
Signal Terminal	24AWG to 22AWG

A7

Waterproof connector



# A9 Waterproof connector

## Applications:

- E-Bike
- E-Scooter
- Drone
- Vacuum Cleaner
- Energy storage battery
- electric lawn mower
- AGV



### Male Connector

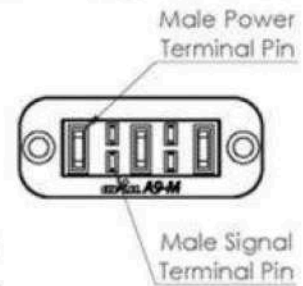
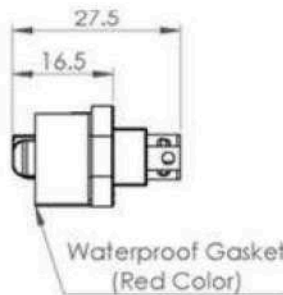
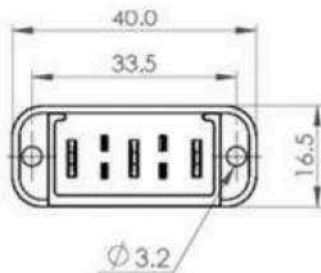

### Female Connector

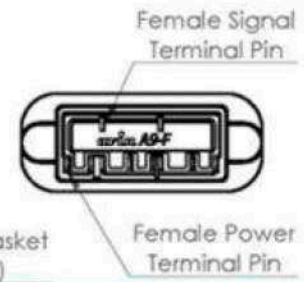
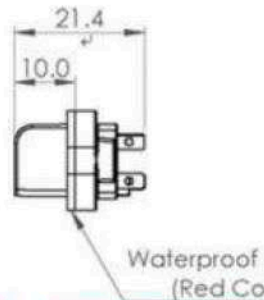
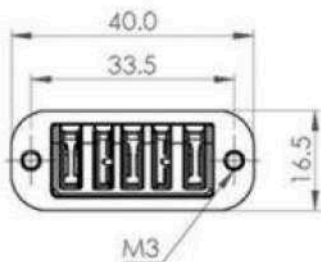

### Features

Terminal	3 PWR. pin & 4 SIG. pin
	PWR.Terminal 25A
Current withstand	(Instantaneous peak current 30A)
	Signal terminal 2-5A
IP rating	IP66
Material of housing	PBT+GF15% UL94 V0

### Wire Information

Wire Spec. for Standard Sample

Wire Gauge

Power Terminal	10AWG
Signal Terminal	24AWG to 22AWG

A9

Waterproof connector

# A10 Waterproof connector

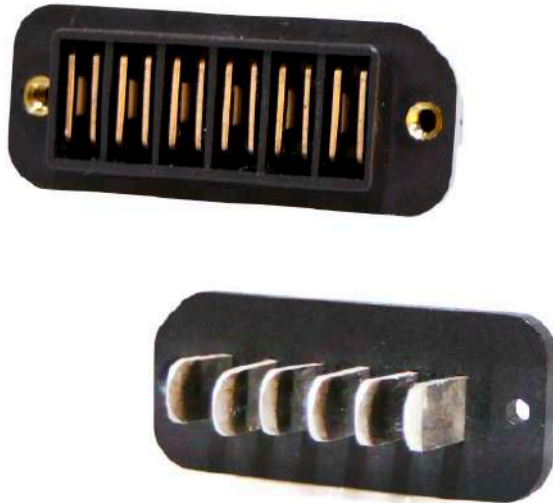

## Applications:

- E-Bike
- E-Scooter
- Drone
- Vacuum Cleaner
- Energy storage battery
- electric lawn mower
- AGV



### Male Connector

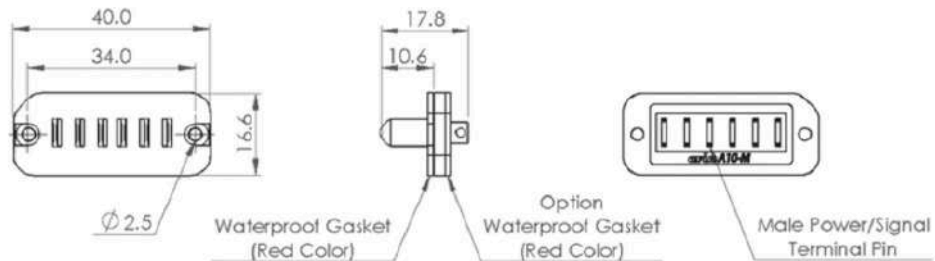

### Female Connector

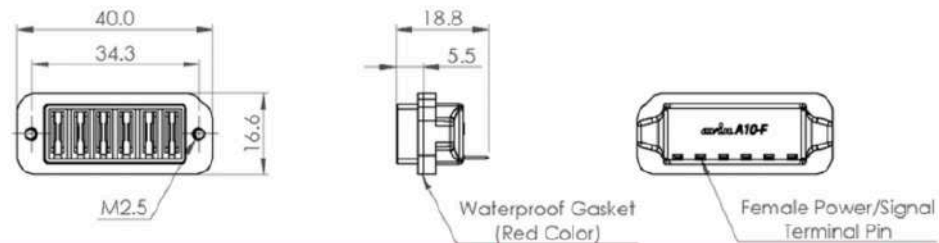

### Features

Terminal	6 PWR. pin & 6 SIG. pin
	PWR.Terminal 25A
Current withstand	(Instantaneous peak current 30A)
	Signal terminal 30A
IP rating	IP66
Material of housing	PBT + GF15% UL94 V0

### Wire Information

#### Wire Spec. for Standard Sample

#### Wire Gauge

Power Terminal	14AWG to 26AWG
Signal Terminal	14AWG to 26AWG



# A15 Waterproof connector

## Applications:

- E-Bike
- E-Scooter
- Drone
- Boat
- Energy storage battery
- electric lawn mower
- AGV

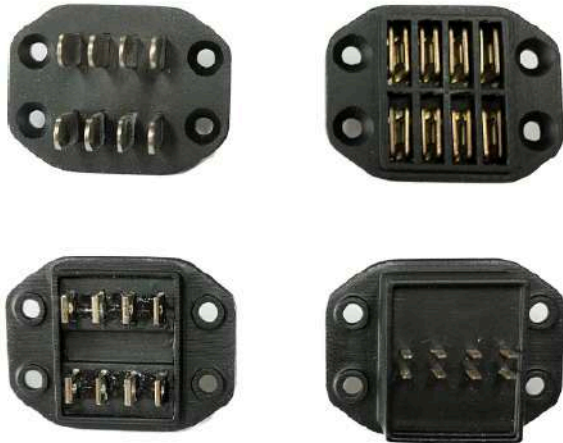

### Female Connector

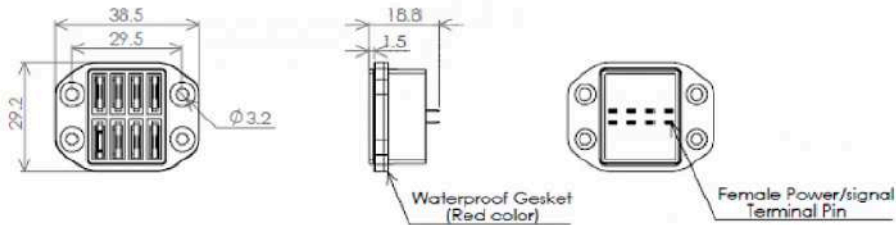

### Dimension

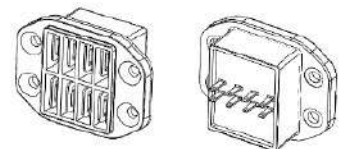

Female Connector

### Male Connector

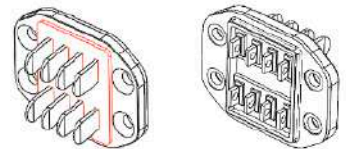
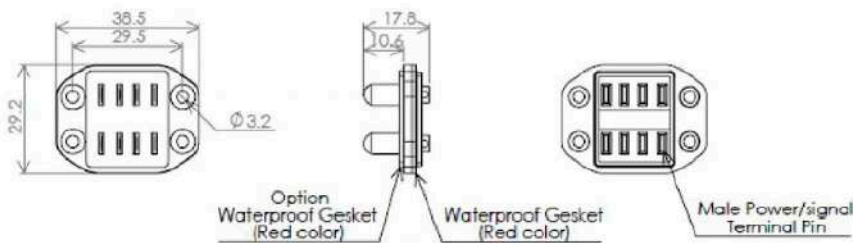

Male Connector

### Features

Terminal	8 PWR. pin & 8 SIG. pin
	PWR. Terminal 25A
Current withstand	(Instantaneous peak current 30A)
	SIG.Terminal 25A (Flash 30A)
IP rating	IP66
Material of housing	PBT+15%GF UL94V0

### Wire Information

Wire Spec. for Standard Sample	
Wire Gauge	
Power Terminal	14AWG to 26AWG
Signal Terminal	14AWG to 26AWG

A15 Waterproof connector

# C1 Waterproof connector



## Applications:

- E-Bike
- E-Scooter
- Drone
- Vacuum Cleaner
- Energy storage battery
- electric lawn mower
- AGV



## Male Connector

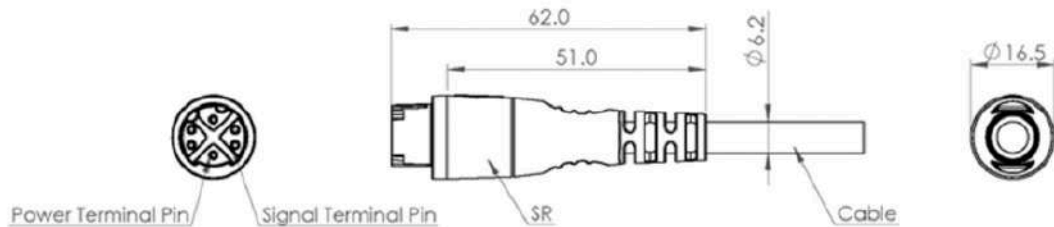

## Female Connector

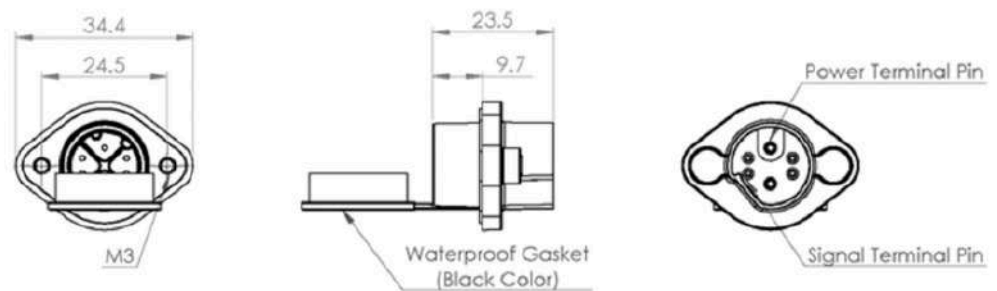

### Features

Terminal	2 PWR. pin & 4 SIG. pin
	PWR. Terminal 10A
Current withstand	(Instantaneous peak current 15A)
	SIG.Terminal 2A
IP rating	IP66
Material of housing	PA66+15%GF UL94V0

### Wire Information

#### Wire Spec. for Standard Sample

#### Wire Gauge

Power Terminal	20AWG
Signal Terminal	26AWG to 24AWG

# B1 Waterproof connector



## Applications:

- E-Bike
- E-Scooter
- Drone
- Vacuum Cleaner
- Energy storage battery
- electric lawn mower
- AGV



Male Connector

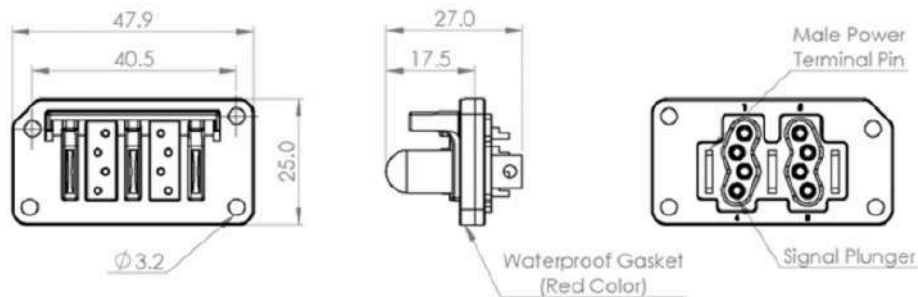

Female Connector

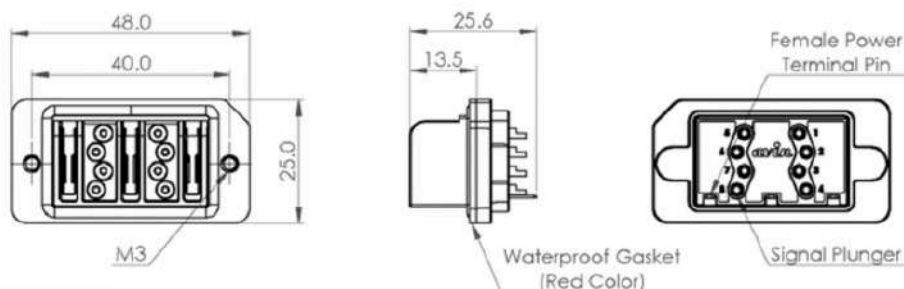

### Features

Terminal	3 PWR. pin & 8 SIG. pin
	PWR. Terminal 25A
Current withstand	(Instantaneous peak current 30A)
	SIG. Terminal 2A(Custization available)
IP rating	IP66
Material of housing	PBT+GF15% UL94 V0

### Wire Information

Wire Spec. for Standard Sample	
Wire Gauge	
Power Terminal	16AWG to 12AWG
Signal Terminal	24AWG to 22AWG



# C2 Waterproof connector



## Applications:

- E-Bike
- E-Scooter
- Drone
- Vacuum Cleaner
- Energy storage battery
- electric lawn mower
- AGV



### Male Connector

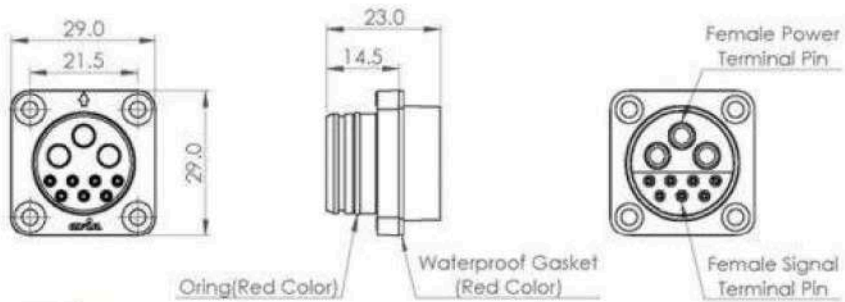

### Female Connector

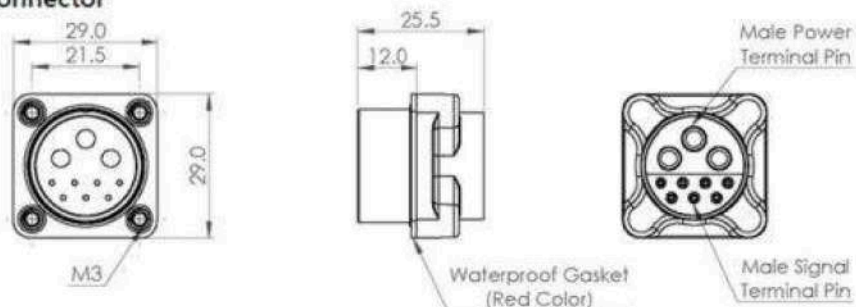

### Features

Terminal	3 PWR. pin & 7 SIG. pin
	PWR. Terminal 30A
Current withstand	(Instantaneous peak current 40A)
	SIG. Terminal 2A
IP rating	IP68
Material of housing	PA66+15%GF UL94V0

### Wire Information

Wire Spec. for Standard Sample	
Wire Gauge	
Power Terminal	14AWG to 10AWG
Signal Terminal	26AWG to 24AWG



# C4 Waterproof connector



## Applications:

- E-Bike
- E-Scooter
- Drone
- Vacuum Cleaner
- Energy storage battery
- electric lawn mower
- AGV

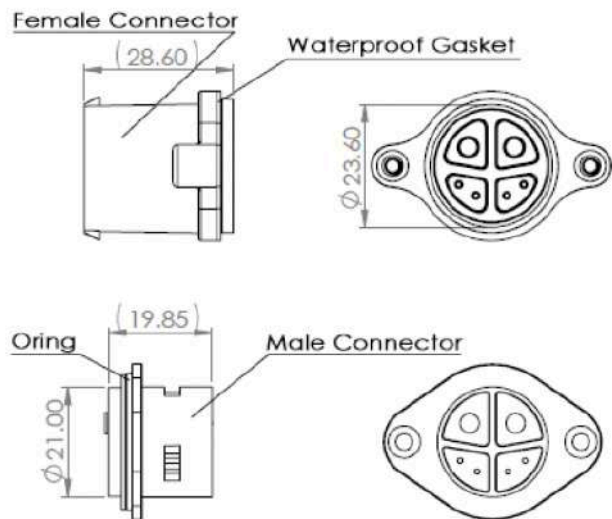
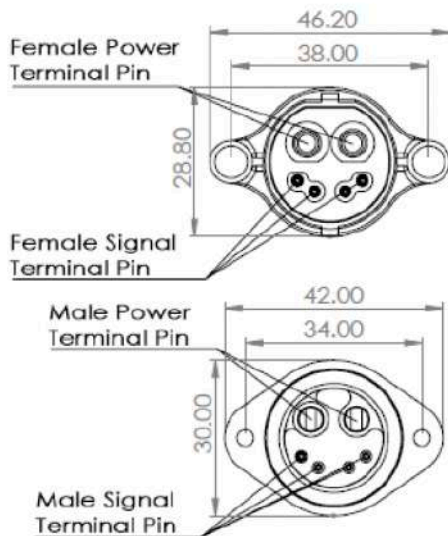

### Features

Terminal	2 PWR. pin & 4 SIG. pin
	PWR. Terminal 30A
Current withstand	(Instantaneous peak current 40A)
	SIG.Terminal 2A
IP rating	IP68
Material of housing	PBT+15%GF UL94 V0

### Wire Information

Wire Spec. for Standard Sample	
Wire Gauge	
Power Terminal	14AWG to 10AWG
Signal Terminal	26AWG to 24AWG

C4 Waterproof connector

# C7 Waterproof connector



## Applications:

- E-Bike
- E-Scooter
- Drone
- Boat
- Energy storage battery
- electric lawn mower
- AGV



### Female Connector

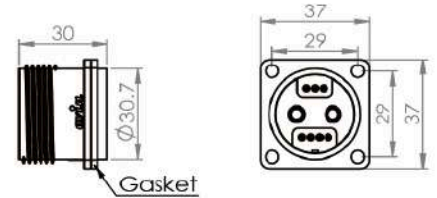
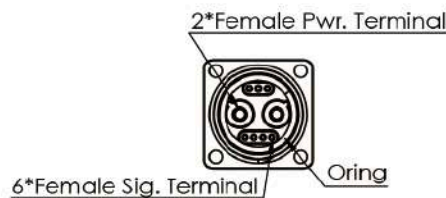
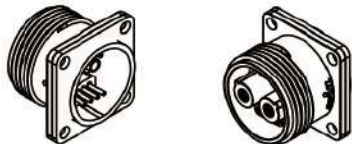

### Male Connector

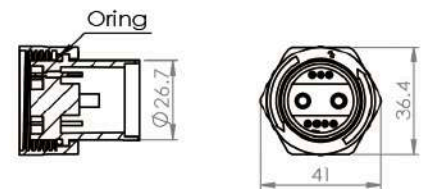
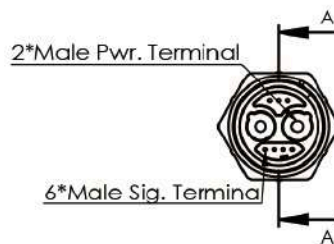
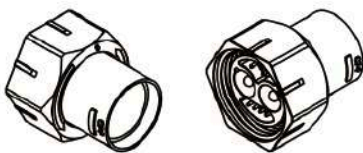

### Features

Terminal	2 PWR. pin & 6 SIG. pin
	PWR. Terminal 30A
Current withstand	(Instantaneous peak current 40A)
	SIG.Terminal 2A
IP rating	IP68 (Underwater 50M/24hr)
Material of housing	PA66+25%GF UL94 V0

### Wire Information

#### Wire Spec. for Standard Sample

#### Wire Gauge

Power Terminal	10AWG
Signal Terminal	24AWG

# D1 Waterproof connector



## Applications:

- E-Bike
- E-Scooter
- Drone
- Vacuum Cleaner
- Energy storage battery
- electric lawn mower
- AGV



E-Bike

E-Scooter

Drone

Vacuum Cleaner

Energy storage battery

electric lawn mower

AGV

### Male Connector

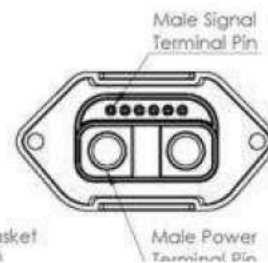
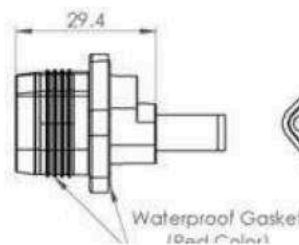
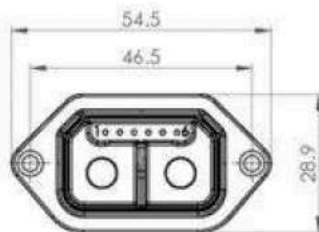

### Female Connector

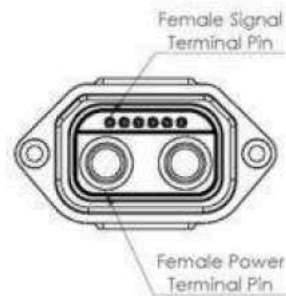
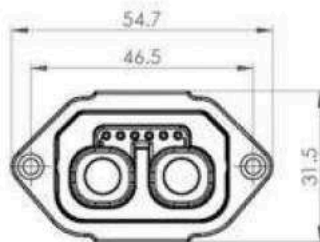

### Features

Terminal	2 PWR. pin & 6 SIG. pin
	PWR. Terminal 80A
Current withstand	(Instantaneous peak current 90A)
	SIG.Terminal 2A
IP rating	IP68
Material of housing	PA66+15%GF UL94 V0

### Wire Information

Wire Spec. for Standard Sample	
Wire Gauge	
Power Terminal	6AWG
Signal Terminal	26AWG to 24AWG

# D2 Waterproof connector

## Applications:

- E-Bike
- E-Scooter
- Drone
- Vacuum Cleaner
- Energy storage battery
- electric lawn mower
- AGV



Male Connector

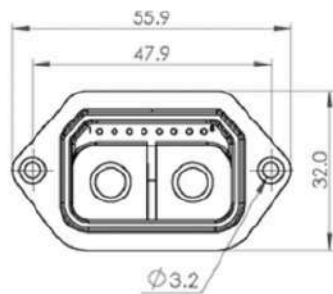

Female Connector

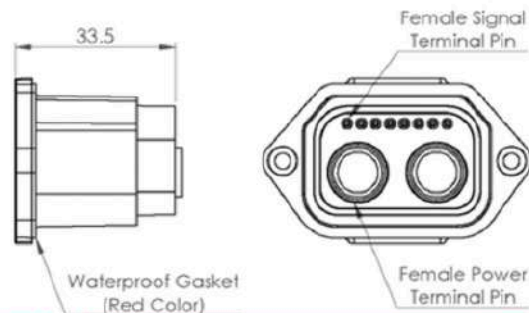
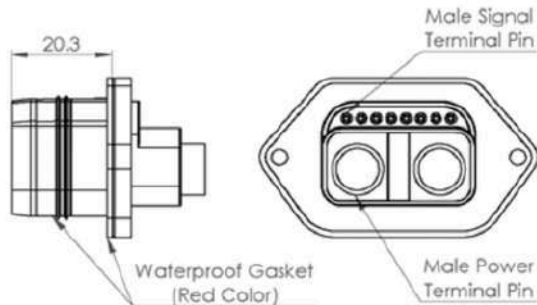
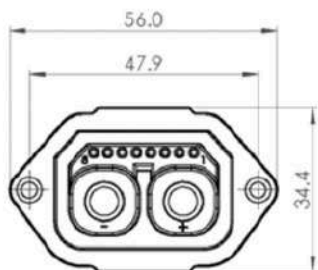

### Features

Terminal	2 PWR. pin & 8 SIG. pin
	100A(4AWG)120A(2AWG)
Current withstand	(Instantaneous peak current 130A)
	SIG.Terminal 2A
IP rating	IP68
Material of housing	PA66+15%GF UL94 V0

### Wire Information

Wire Spec. for Standard Sample	
Wire Gauge	
Power Terminal	4AWG to 2AWG
Signal Terminal	26AWG to 24AWG